

## / Descriptions

TO-3P

## / Features

## / Applications

## / Equivalent Circuit

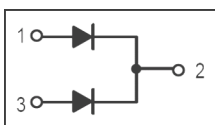

## / Pinning

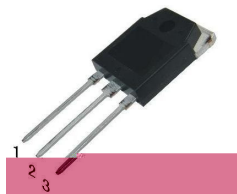

## / h<sub>FE</sub> Classifications & Marking

**MBR2045PT**

|  |  |  |  |
|--|--|--|--|
|  |  |  |  |
|--|--|--|--|

/ Electrical Characteristic Curve

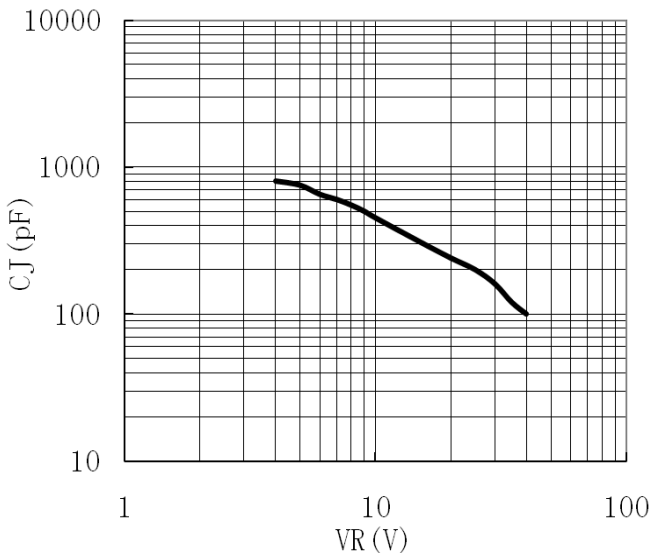
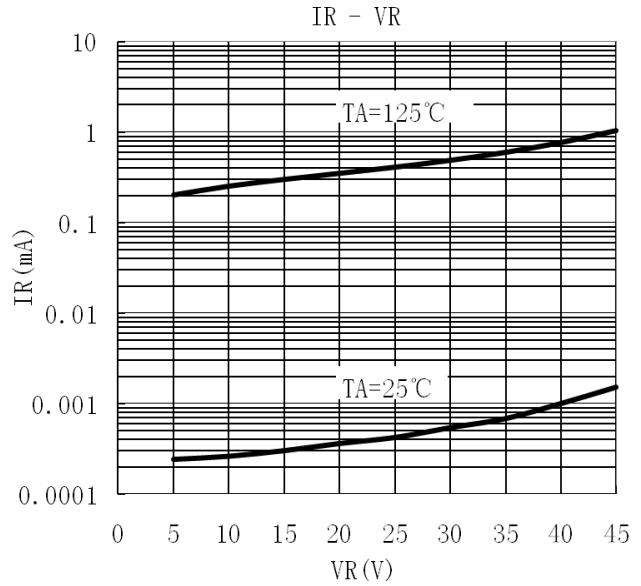
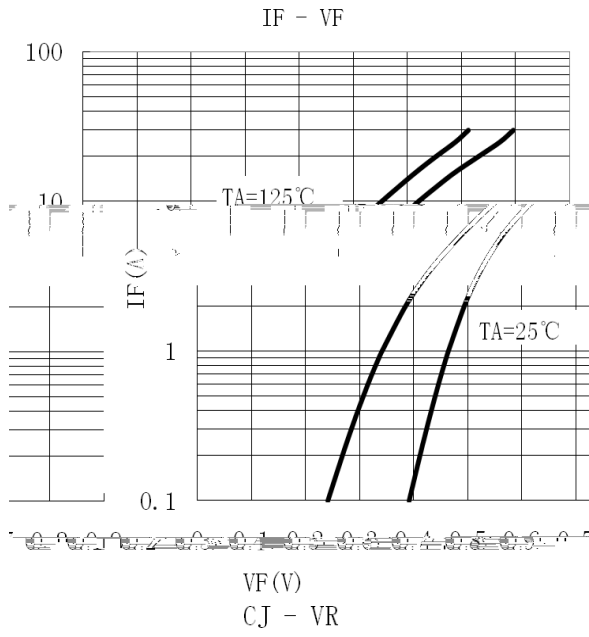
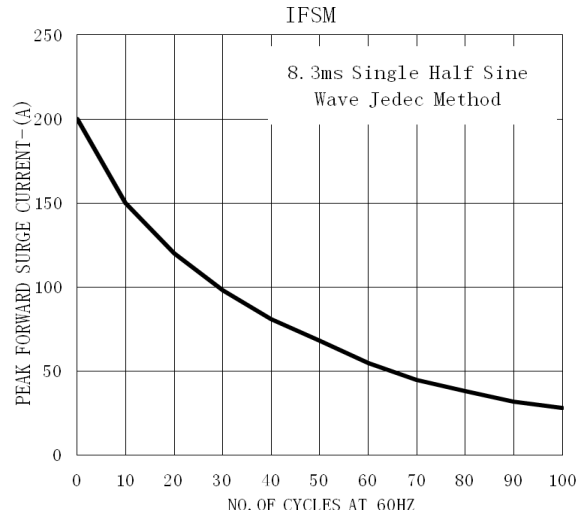
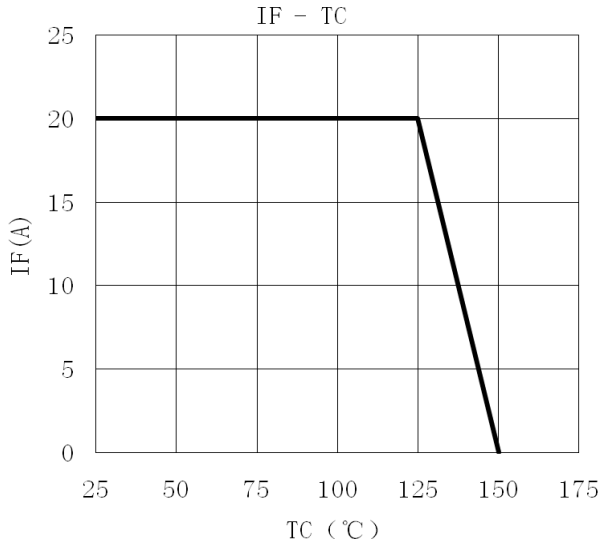

/ Package Dimensions

1U-3P

单位: mm

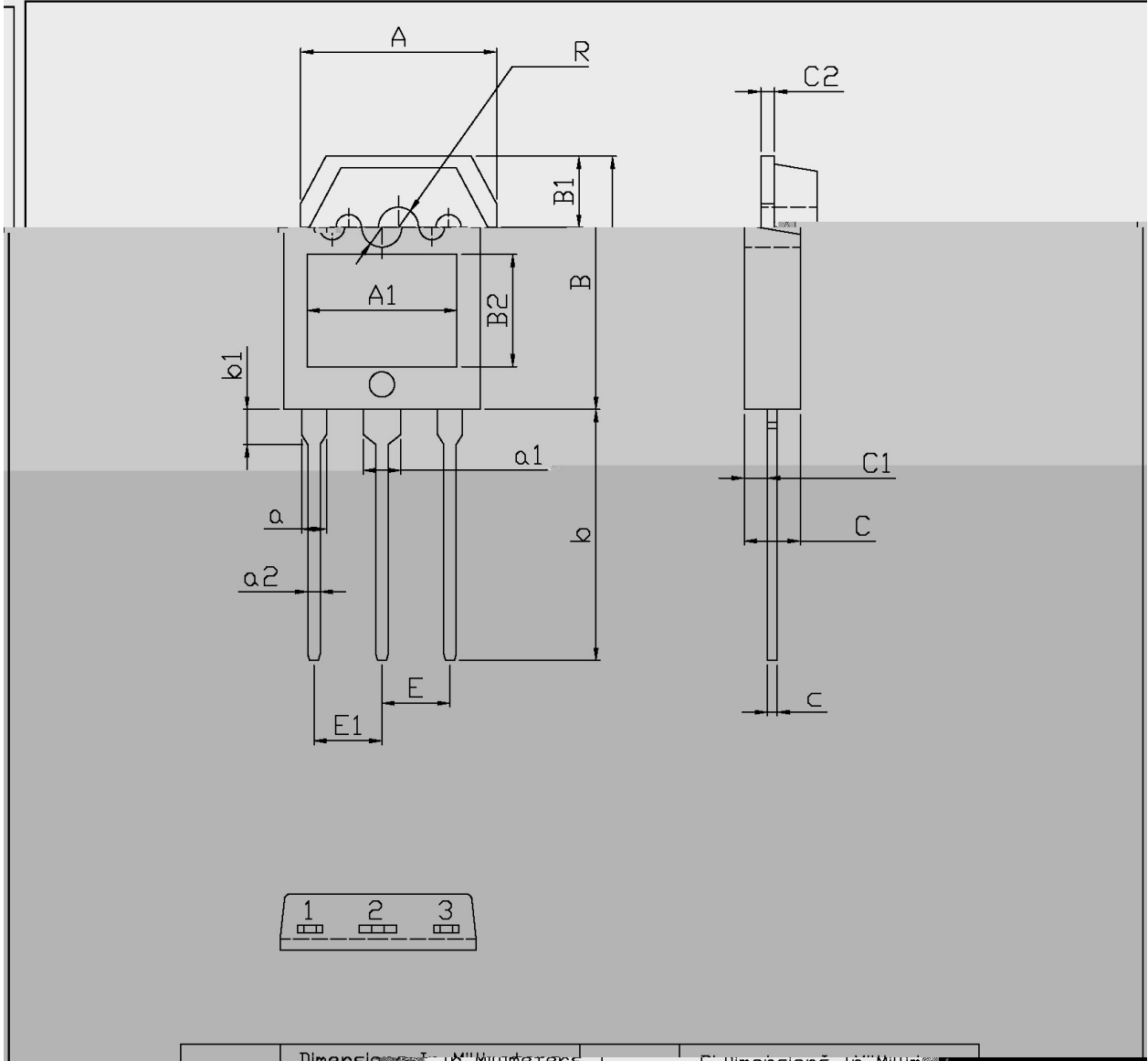

Dimension in mm (Metric) / Dimension in inch (Imperial)

/ Marking Instructions

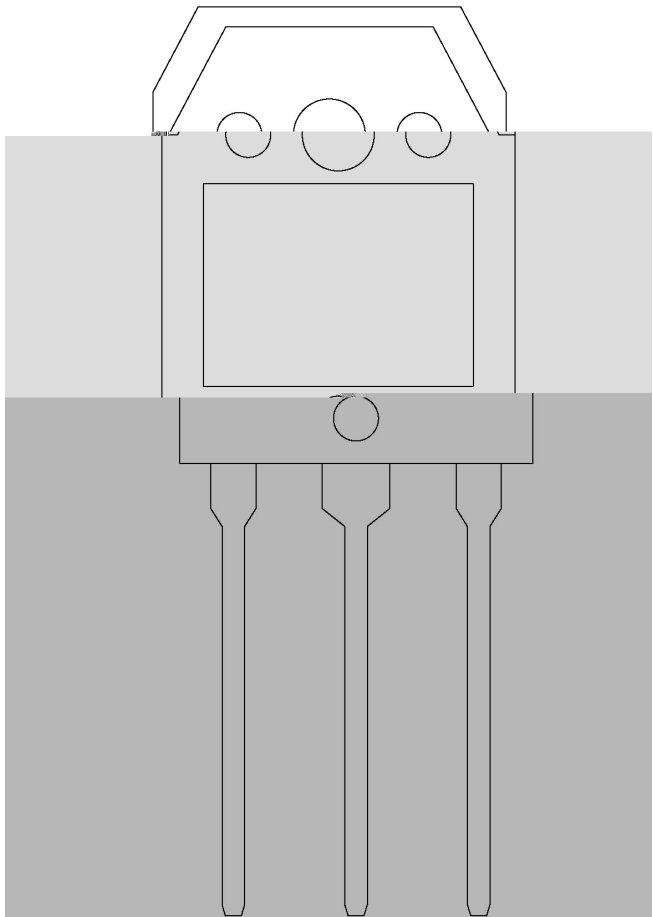

\*\*\*\*

( ) / Temperature Profile for Dip Soldering(Pb-Free)

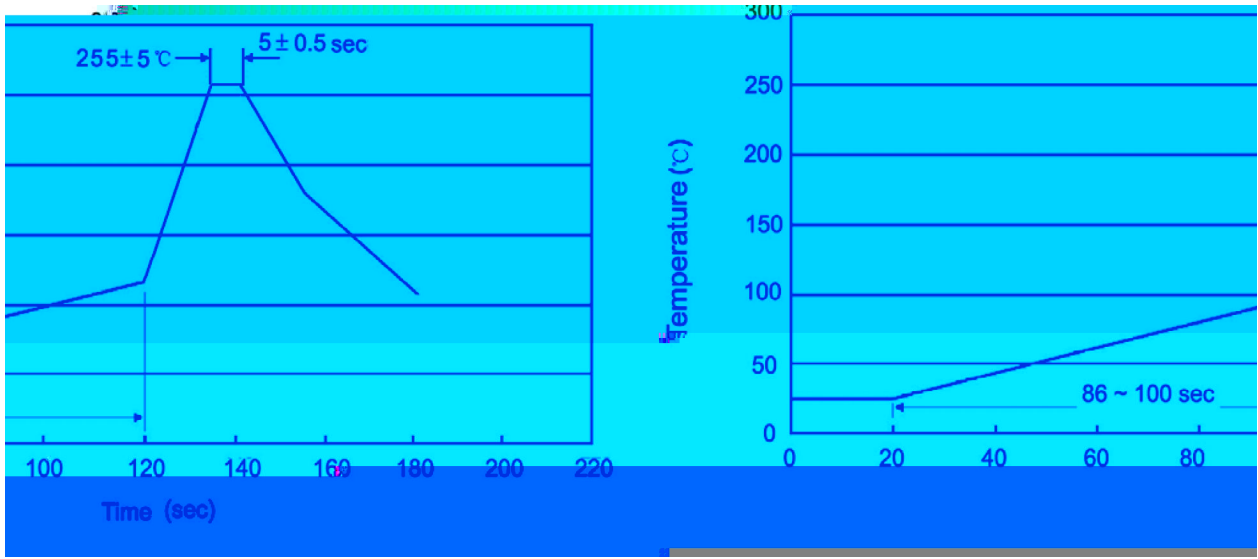

± ± ± ±

/ Resistance to Soldering Heat Test Conditions

± ± °C

/ Packaging SPEC.

|  |  |  |  |  |  |  |  |  |
|--|--|--|--|--|--|--|--|--|
|  |  |  |  |  |  |  |  |  |
|  |  |  |  |  |  |  |  |  |

/ Notices