

/ Descriptions

TO-3P

/ Features

/ Applications

OR-ing

DC-DC

/ Equivalent Circuit

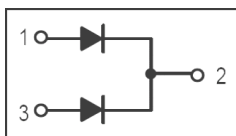

/ Pinning

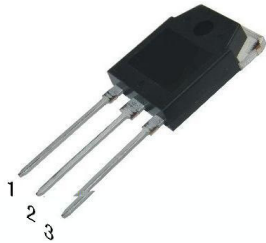

/ h_{FE} Classifications & Marking

/ Absolute Maximum Ratings(Ta=25)

| | | | |
|--|--|--|--|
| | | | |
| | | | |
| | | | |
| | | | |
| | | | |
| | | | |
| | | | |

/ Electrical Characteristics(Ta=25)

| | | | | | | |
|--|--|--|--|--|--|--|
| | | | | | | |
| | | | | | | |
| | | | | | | |
| | | | | | | |
| | | | | | | |
| | | | | | | |
| | | | | | | |
| | | | | | | |

- /
- 1.
- 2.

/ Electrical Characteristic Curve

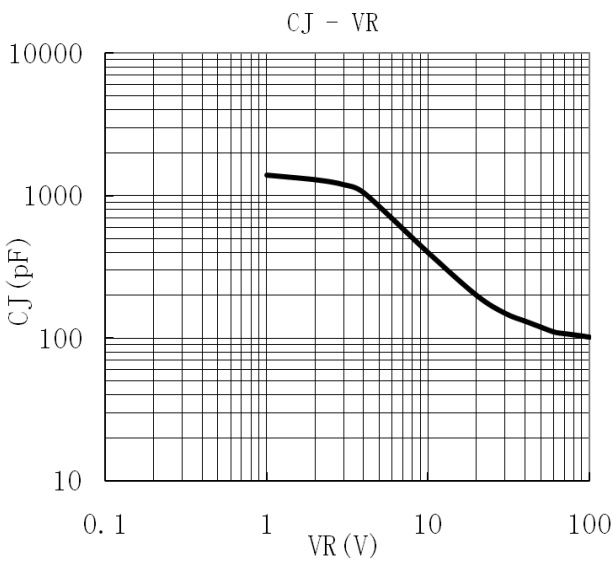
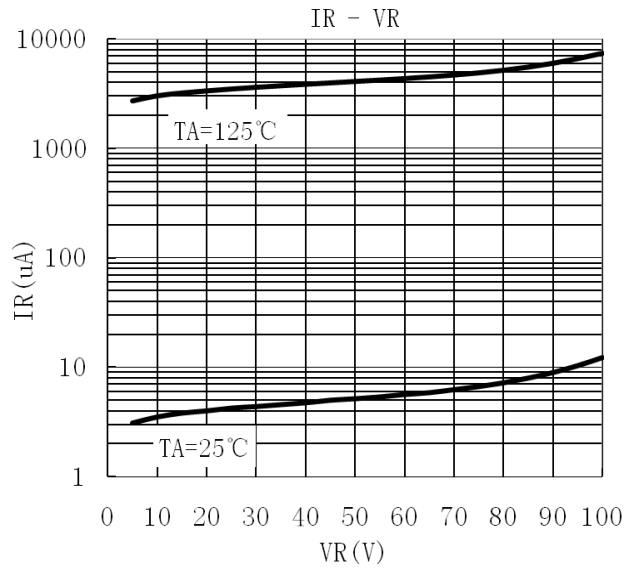
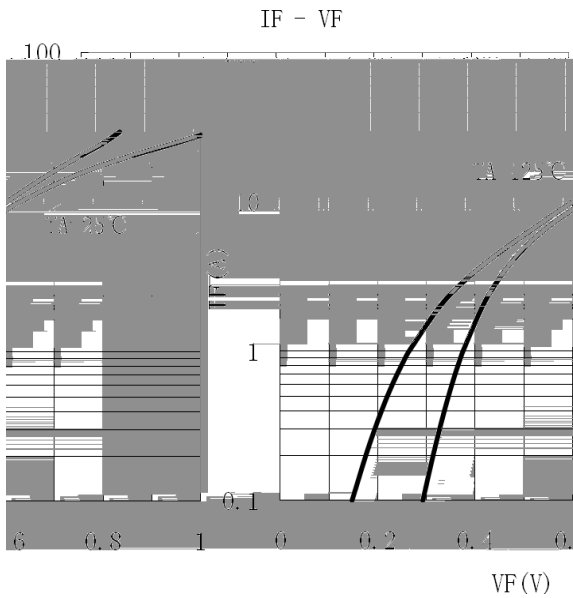
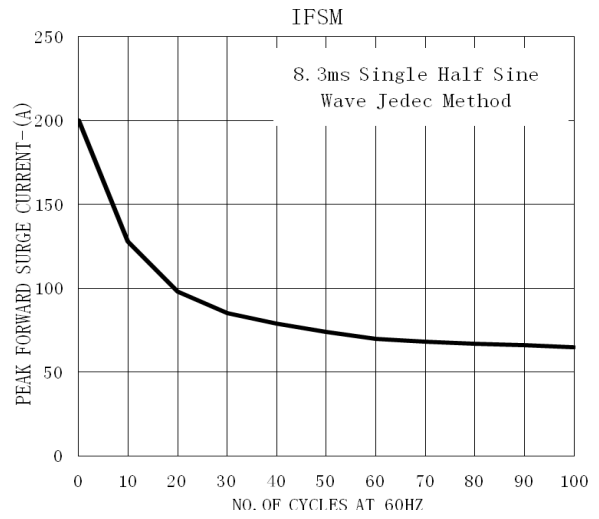
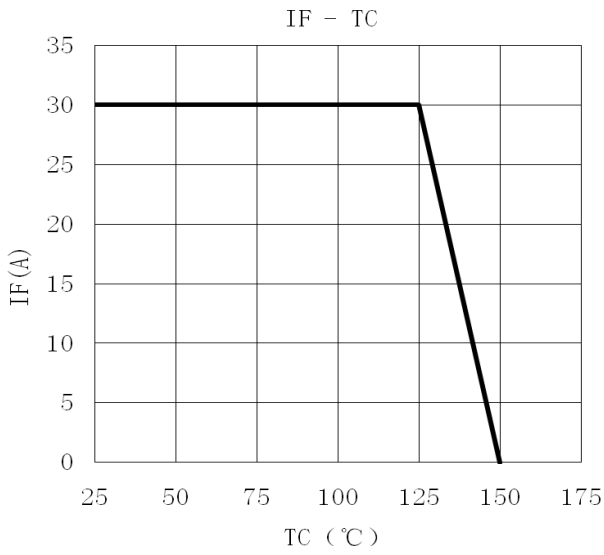

/ Package Dimensions

TQ-3P

单位: mm

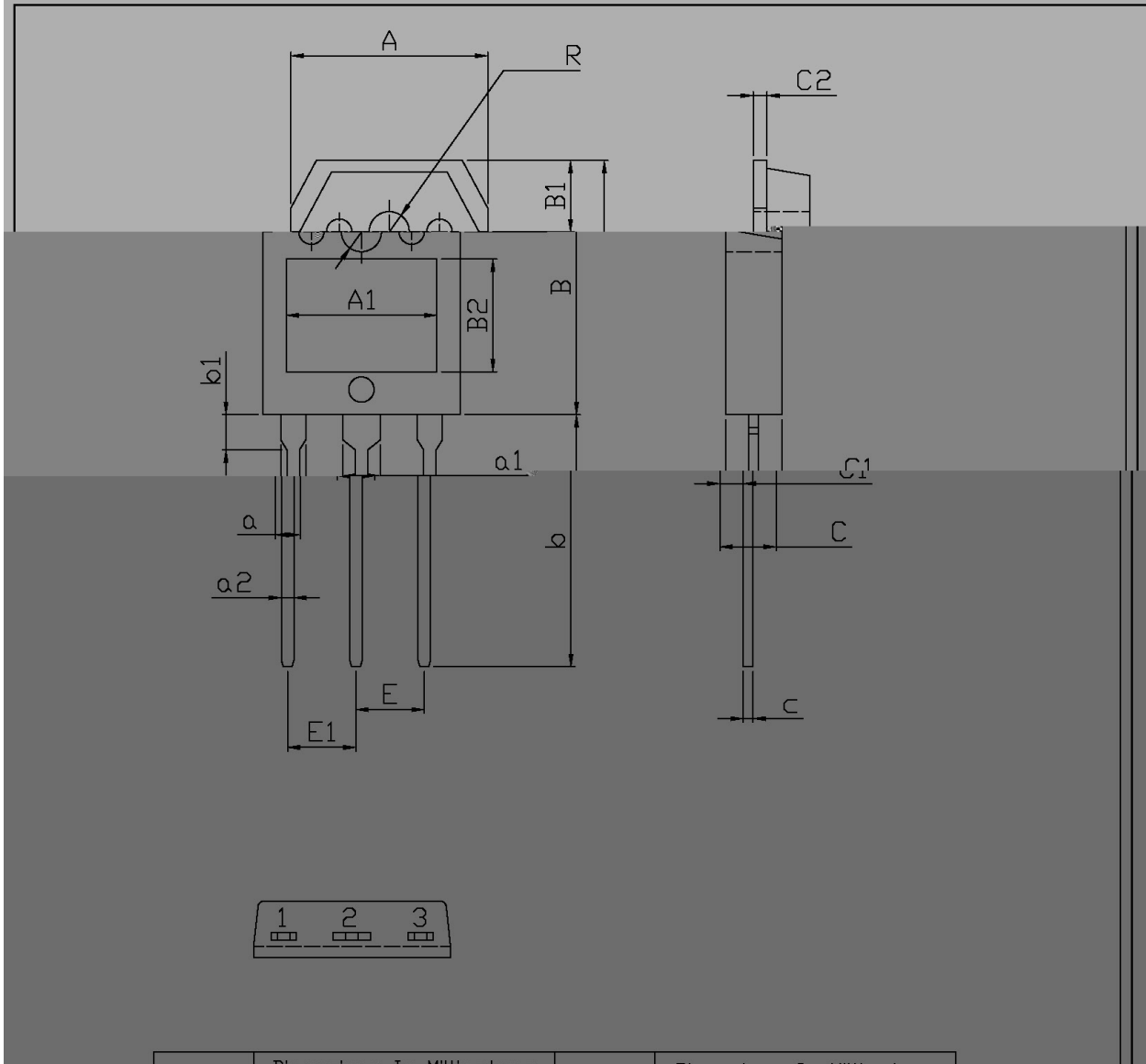

/ Marking Instructions

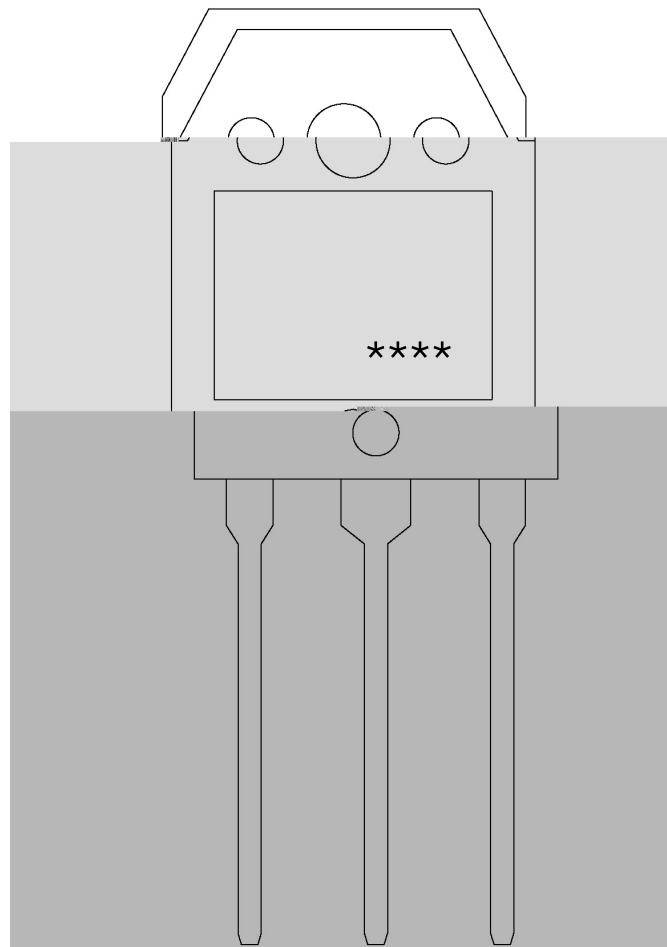

BR

LV30100PT

() / Temperature Profile for Dip Soldering(Pb-Free)

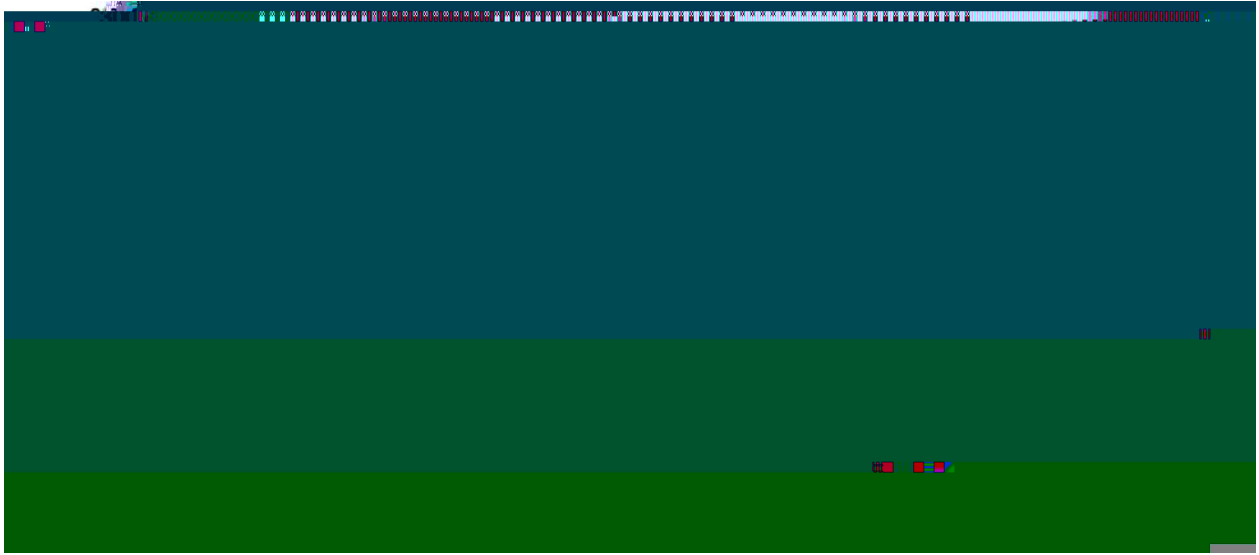

± ± ± ±

/ Resistance to Soldering Heat Test Conditions

± ±

/ Packaging SPEC.

| 封装形式 | 包装数量 | | | | | 包装尺寸 : | | |
|-------|--------------------|-------------------------|------------------------|------------------------------|------------------------|------------|-------------|-------------|
| | Units/Tube 只/套管 | Tubes/Inner Box 套管/盒 | Units/Inner Box 只/盒 | Inner Boxes/Outer Box 盒/箱 | Units/Outer Box 只/箱 | Tube 套管 | Inner Box 盒 | Outer Box 箱 |
| TO-3P | 30 | 15 | 450 | 5 | 2250 | 497.5×46×8 | 555×164×50 | 575×290×180 |

/ Notices