

# KSD471A

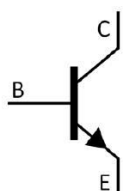

**/ Absolute Maximum Ratings(Ta=25 )**

**/ Electrical Characteristics(Ta=25 )**

		$\mu$				
		$\mu$				
						$\mu$

/ Electrical Characteristic Curve

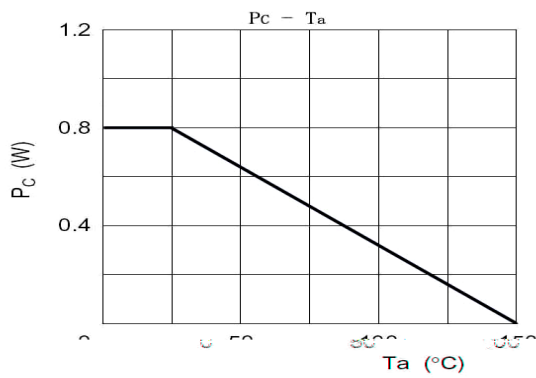
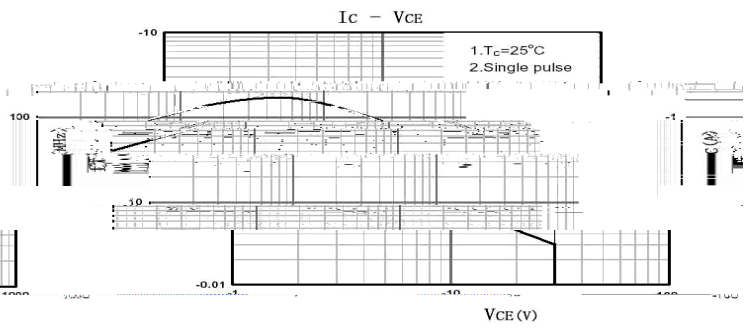
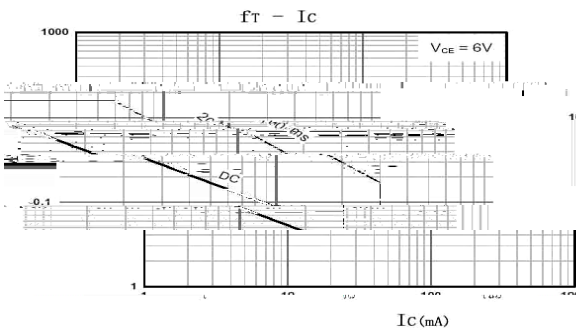
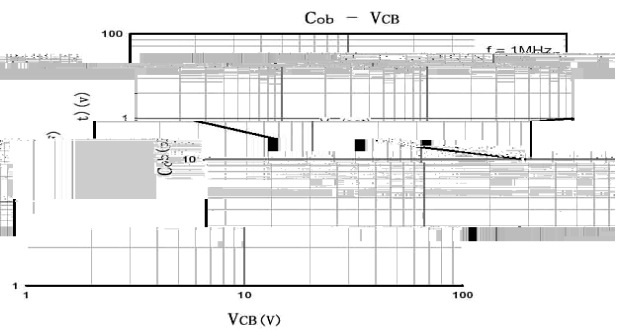
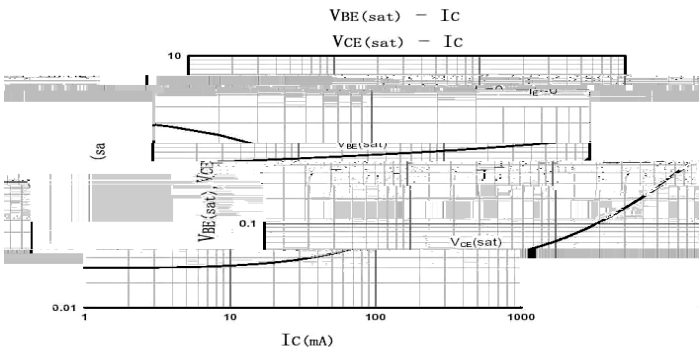
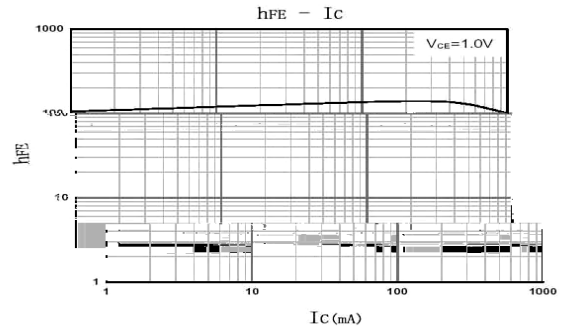
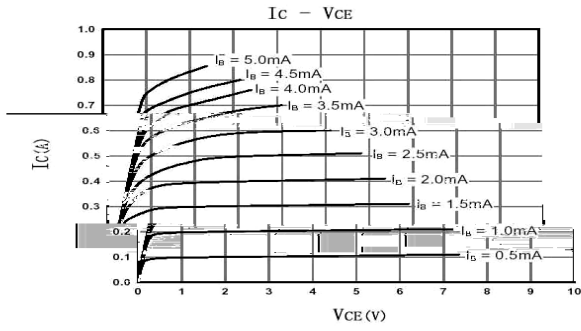

/ Package Dimensions

TO-92

Unit: mm

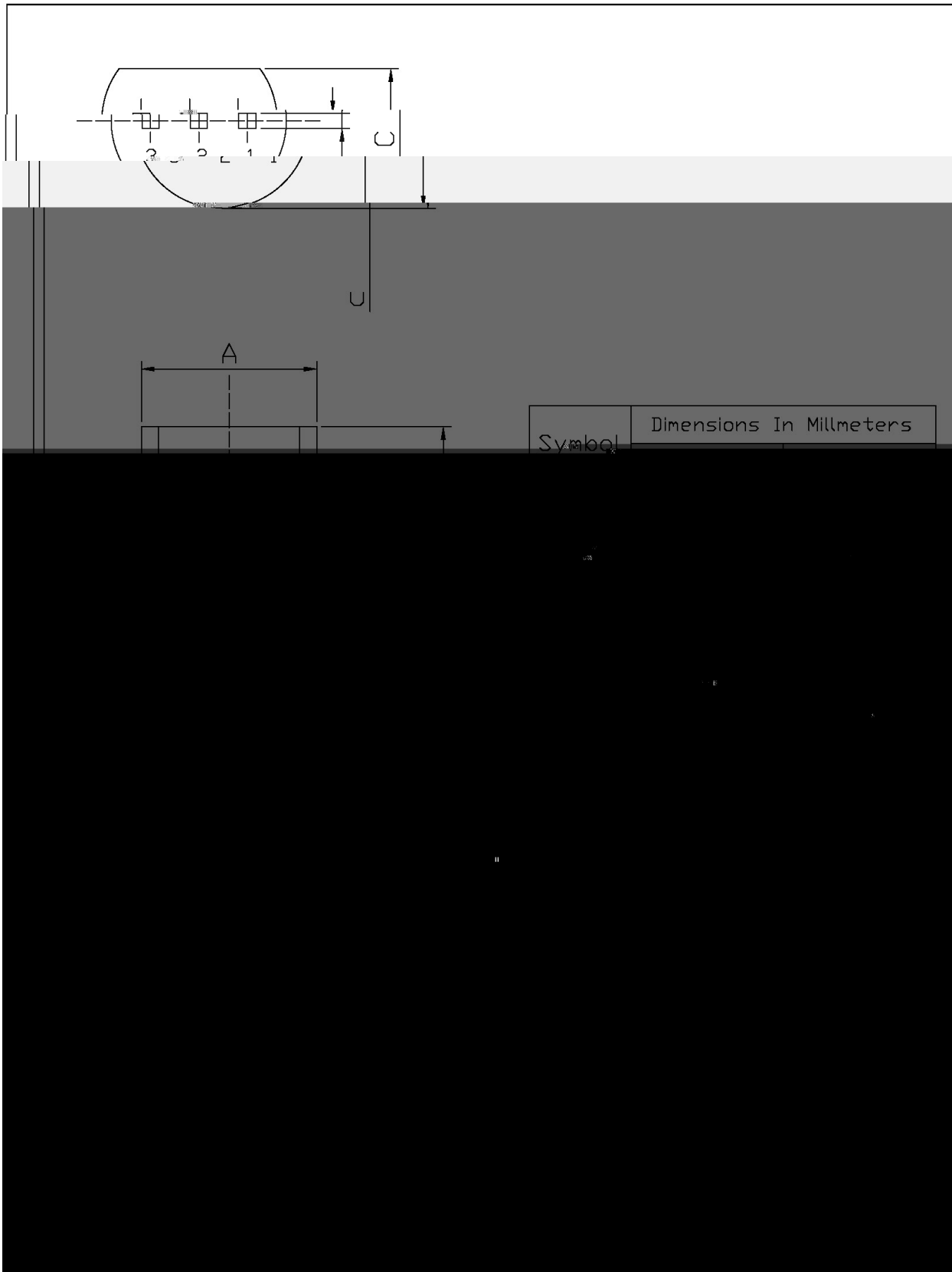

Symbol	Dimensions In Millimeters
--------	---------------------------

/ Marking Instructions

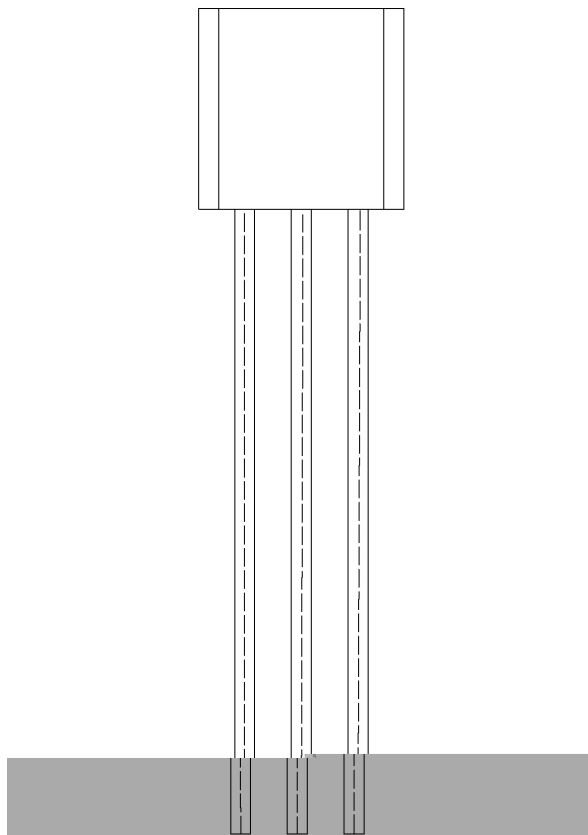

( ) / Temperature Profile for Dip Soldering(Pb-Free)

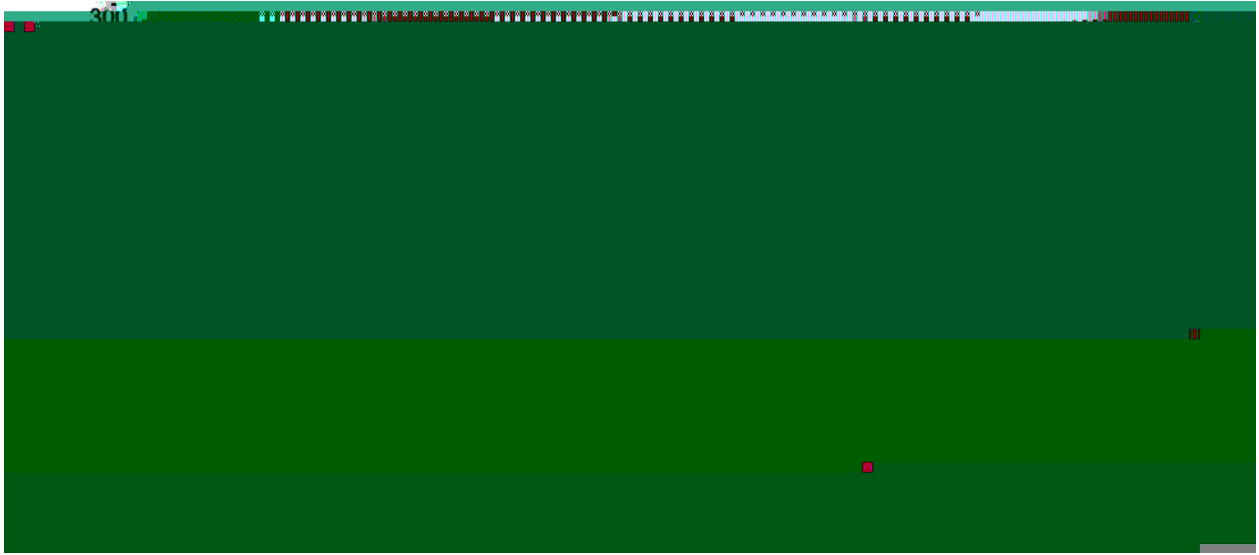

/ Resistance to Soldering Heat Test Conditions

/ Packaging SPEC.



/ Notices