

# KSD1616(A)

## / Descriptions

TO-92      NPN

## / Features

KSB1116(A)

## / Applications

## / Equivalent Circuit

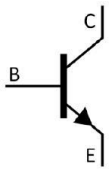

## / Pinning



## / hFE Classifications & Marking

# KSD1616(A)

		KSD1616	
		KSD1616A	
		KSD1616	
		KSD1616A	

/ Electrical Characteristic Curve

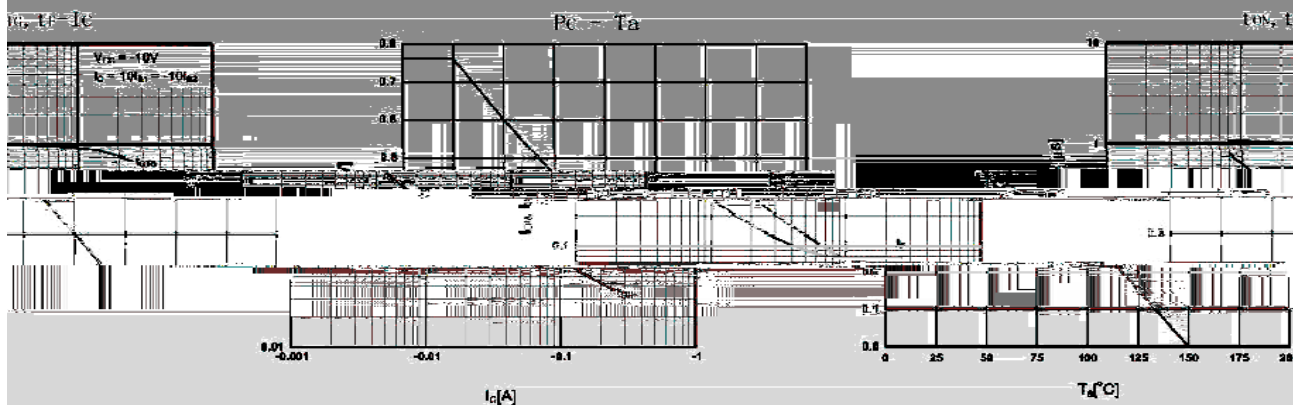
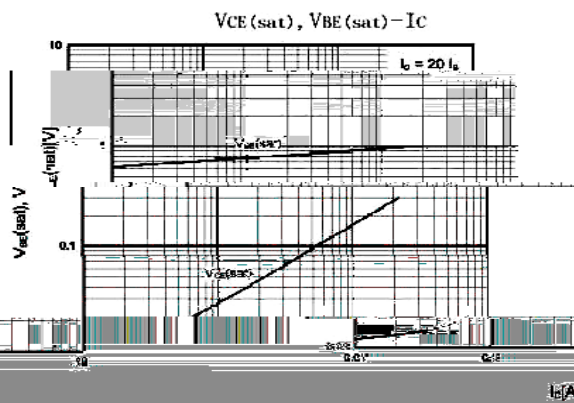
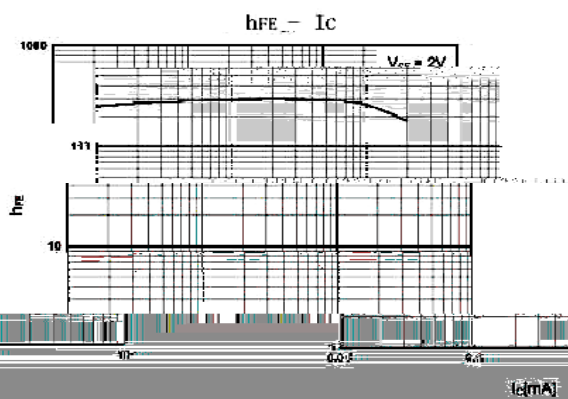
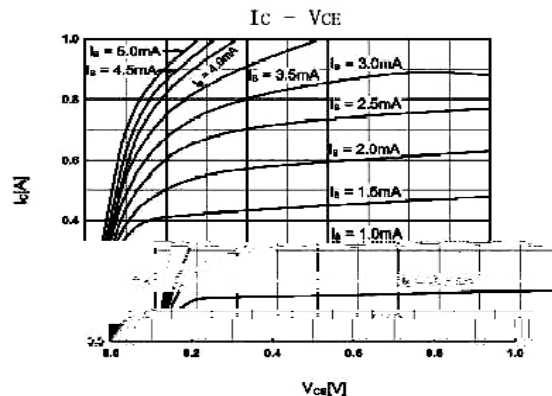
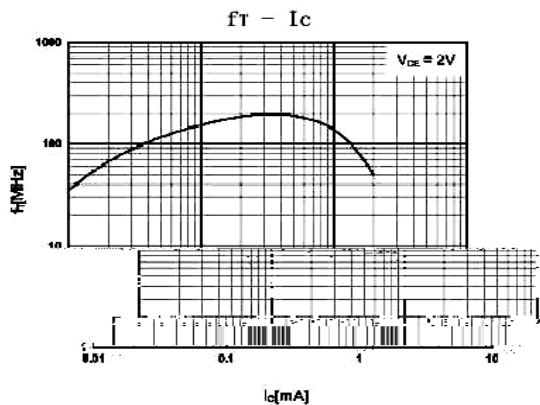



/ Marking Instructions

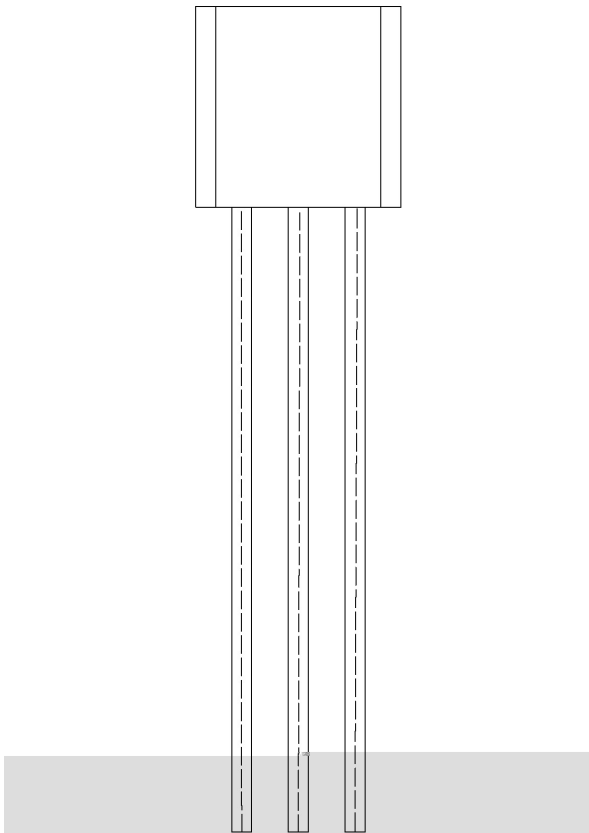

BR:

D1616A

Y:

\*\*\*\*

( ) / Temperature Profile for Dip Soldering(Pb-Free)

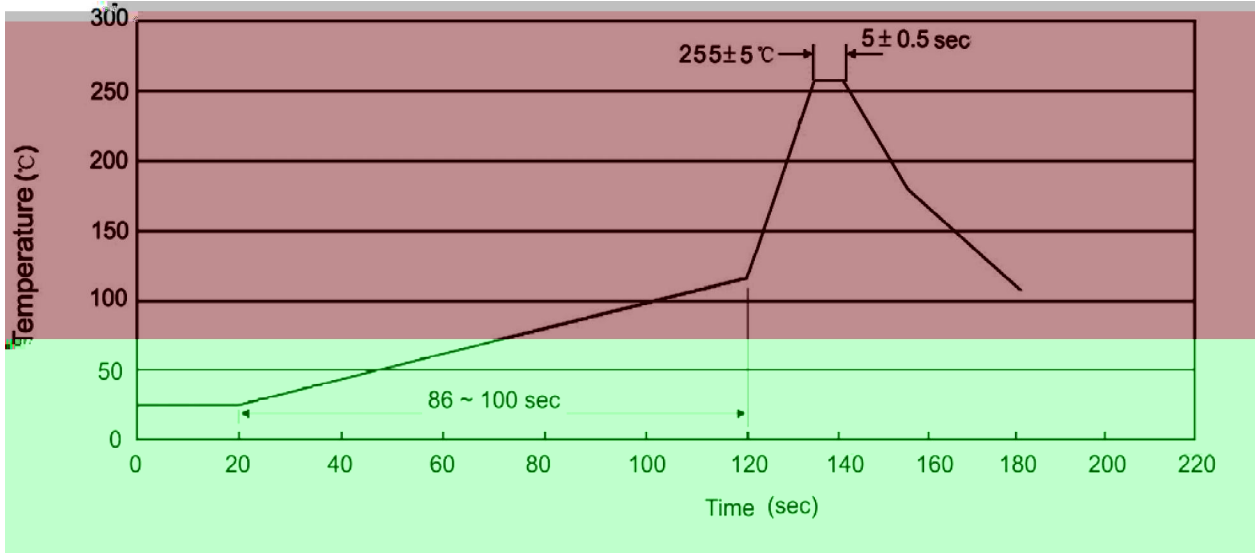

± ± ± ±

/ Resistance to Soldering Heat Test Conditions

± ±

/ Packaging SPEC.

封装形式	包装数量					包装尺寸 :		
	只袋	袋盒	只盒	盒箱	只箱	袋	盒	箱

封装形式	包装数量					包装尺寸 :	
	只纸带	纸带盒	纸带层盒	盒箱	只箱	盒	箱
						小箱	大箱

/ Notices