

/ Absolute Maximum Ratings(Ta=25)

Parameter	Symbol	Rating	Unit
Collector to Base Voltage	V_{CBO}	80	V
Collector to Emitter Voltage	V_{CEO}	60	V
Emitter to Base Voltage	V_{EBO}	8.0	V
Collector Current (DC)	I_C	700	mA
Collector Power Dissipation	P_C	1.0	W
Junction Temperature	T_j	150	
Storage Temperature Range	T_{stg}	-55 150	

/ Electrical Characteristics(Ta=25)

Parameter	Symbol	Test Conditions	Min	Typ	Max	Unit
Collector to Base Breakdown Voltage	V_{CBO}	$I_C=100\mu A$ $I_E=0$	80			V
Collector to Emitter Breakdown Voltage	V_{CEO}	$I_C=10mA$ $I_B=0$	60			V
Emitter to Base Breakdown Voltage	V_{EBO}	$I_E=-10\mu A$ $I_C=0$	8.0			V
Collector Cut-Off Current	I_{CBO}	$V_{CB}=60V$ $I_E=0$			0.1	μA
Emitter Cut-Off Current	I_{EBO}	$V_{EB}=5.0V$ $I_C=0$			0.1	μA
DC Current Gain	h_{FE}	$V_{CE}=2.0V$ $I_C=50mA$	40		240	
Collector to Emitter Saturation Voltage	$V_{CE(sat)}$	$I_C=500mA$ $I_B=50mA$		0.2	0.7	V
Base to Emitter Saturation Voltage	$V_{BE(sat)}$	$I_C=500mA$ $I_B=50mA$		0.86	1.2	V
Transition Frequency	f_T	$V_{CE}=10V$ $I_C=50mA$	30	50		MHz
Collector output capacitance	C_{ob}	$V_{CB}=10V$ $I_E=0$ $f=1.0MHz$		8.0		pF

/ Electrical Characteristic Curve

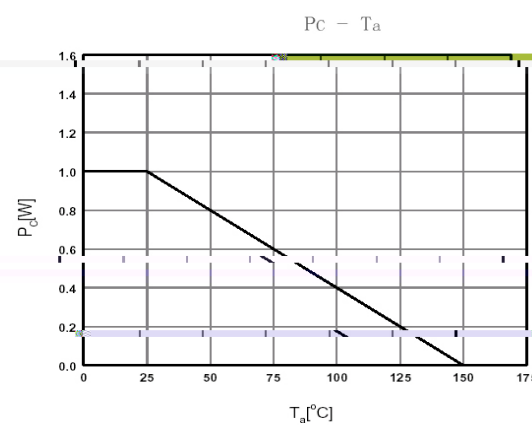
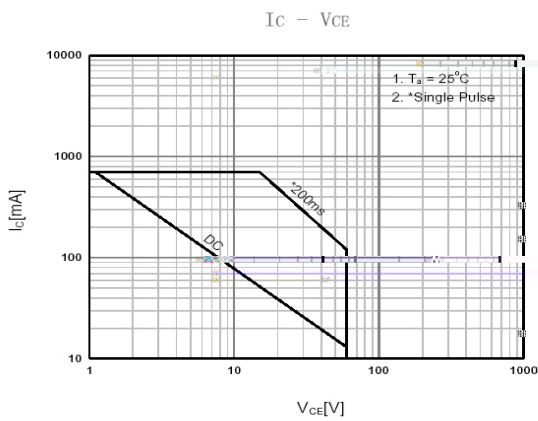
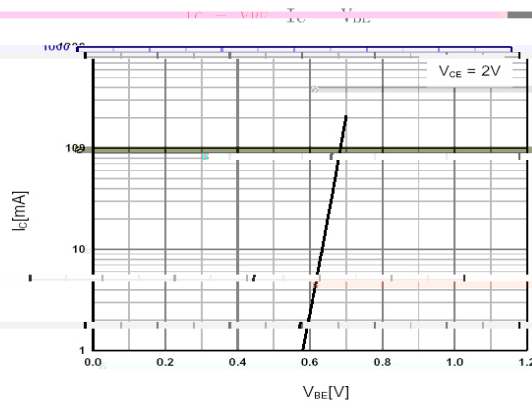
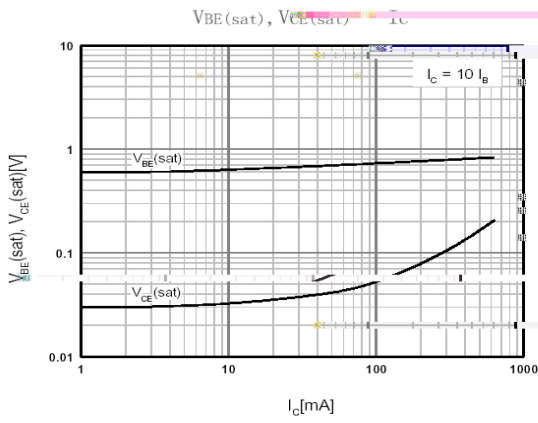
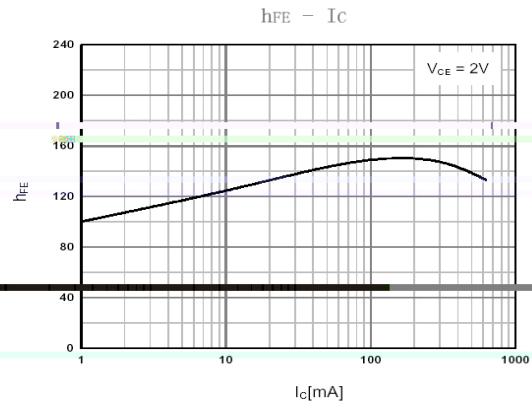
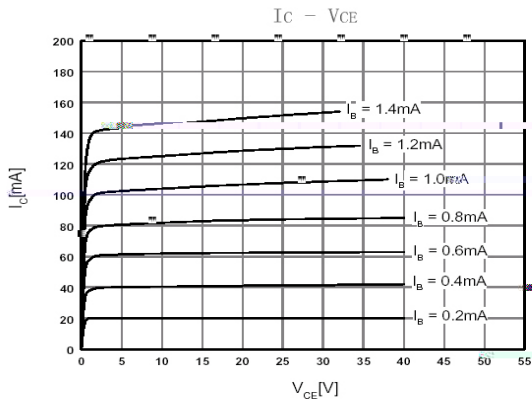

/ Package Dimensions

T0-92LM

Unit: mm

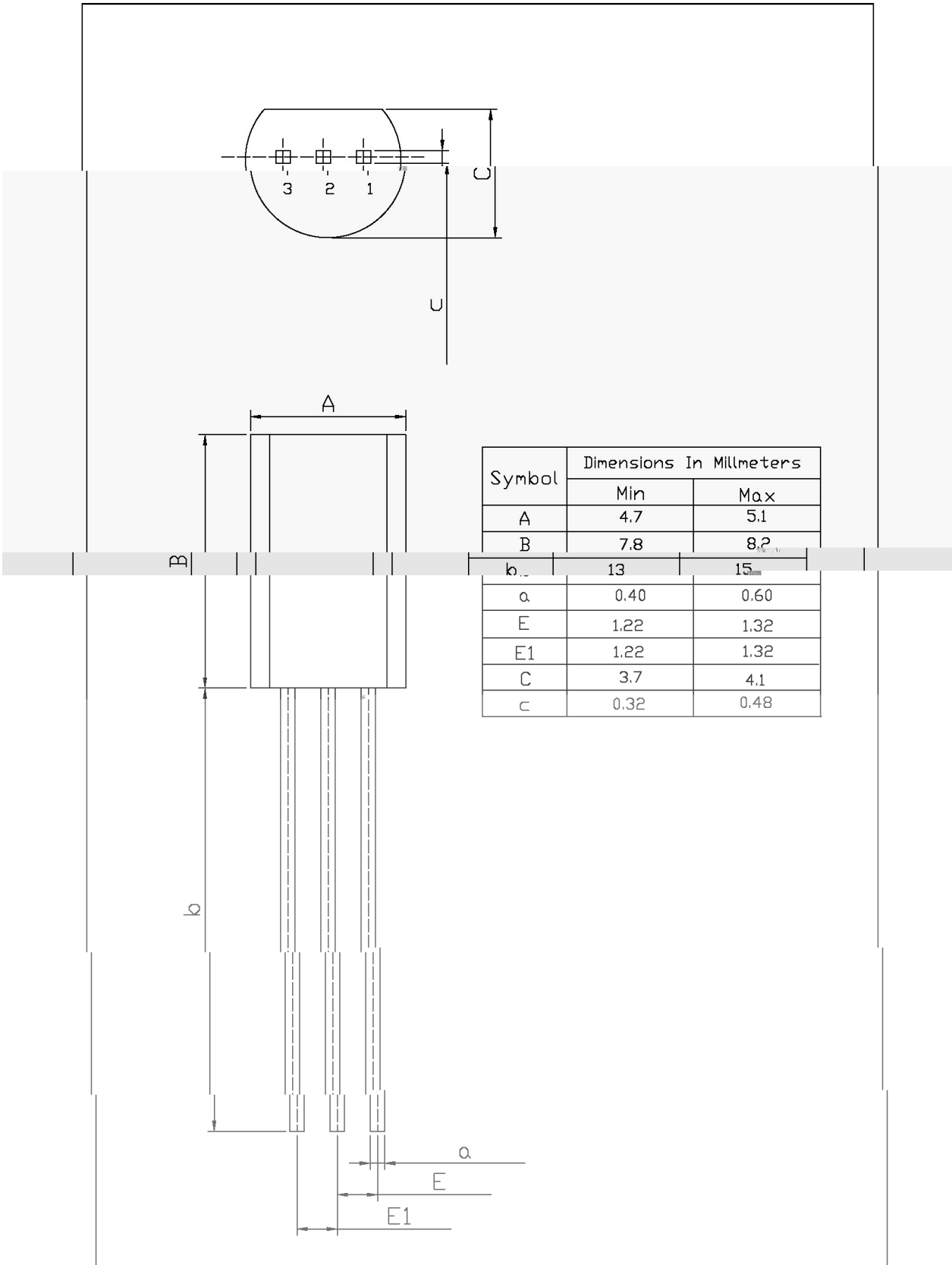

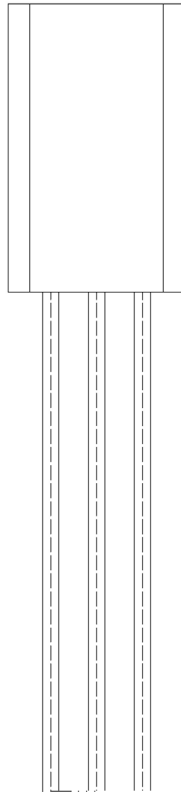

() / Temperature Profile for Dip Soldering(Pb-Free)

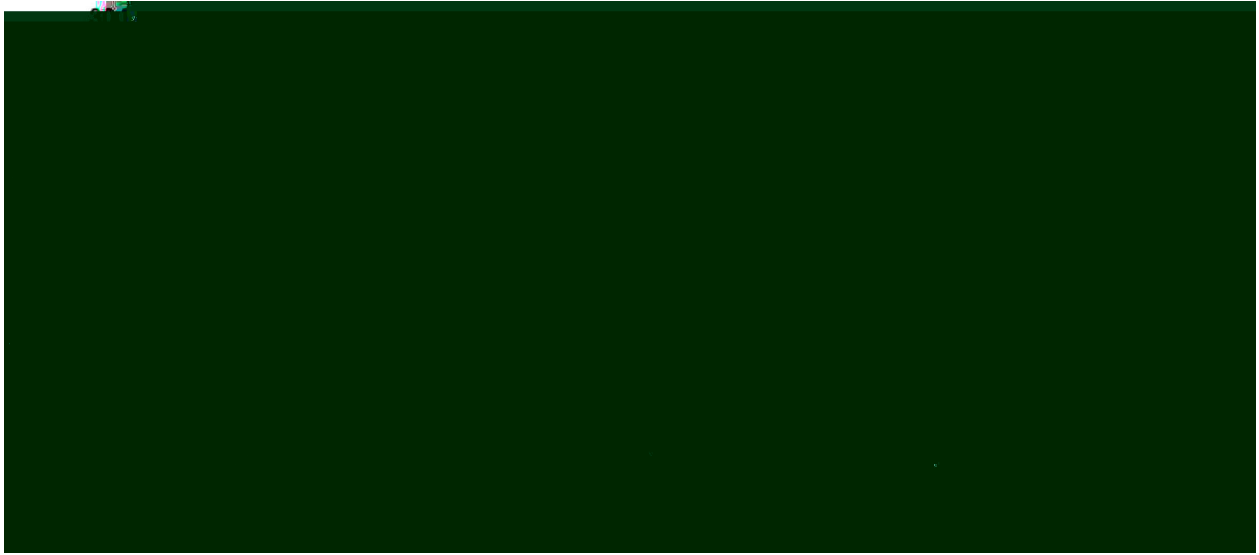

Note:

- | | | | | | |
|---|-----|-----|----|----------|-----------------------------------------|
| 1 | 25 | 150 | 60 | 90sec; | 1.Preheating:25~150 , Time:60~90sec. |
| 2 | 255 | 5 | 5 | 0.5sec; | 2.Peak Temp.:255 5 , Duration:5 0.5sec. |
| 3 | | | 2 | 10 /sec. | 3. Cooling Speed: 2~10 /sec. |

/ Resistance to Soldering Heat Test Conditions

270 5 10 1 sec. Temp.:270±5 Time:10±1 sec

/ Packaging SPEC.

/ BULK

Package Type 封装形式	Units 包装数量					Dimension 包装尺寸 (unit: mm3)		
	Units/Bag 只/袋	Bags/Inner Box 袋/盒	Units/Inner Box 只/盒	Inner Boxes/Outer Box 盒/箱	Units/Outer Box 只/箱	Bag 袋	Inner Box 盒	Outer Box 箱
TO-92LM	1,000	8	8,000	5	40,000	135×190	237×172×102	560×245×195

/ AMMO

Package Type 封装形式	Units 包装数量					Dimension 包装尺寸 (unit: mm3)	
	Units/tape 只/纸带	Tape/Inner Box 纸带/盒	Rows/Inner Box 纸带层/盒	Inner Boxes/Outer Box 盒/箱	Units/Outer Box 只/箱	Inner Box 盒	Outer Box 箱
TO-92LM	2,500	1	100	10	25,000	328×230×42	小箱 480×346×235 大箱 547×407×268

/ Notices