

Rev.E Mar.-2016

TO-92LM NPN Silicon NPN transistor in a TO-92LM Plastic Package.

KSA 928A
 complementary pair with KSA928A.

Audio frequency amplifier applications.



PIN1 Base PIN 2 Collector PIN 3 Emitter

h_{FE} Classifications Symbol	O	Y
h_{FE} Range		

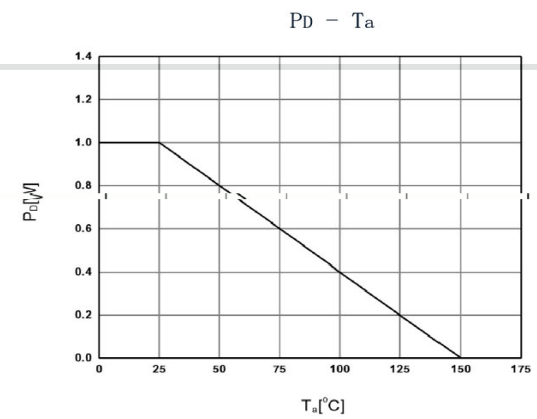
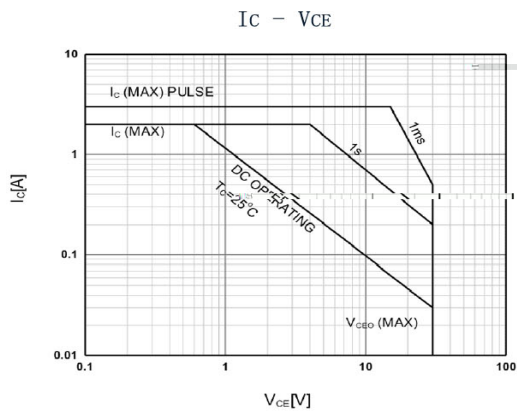
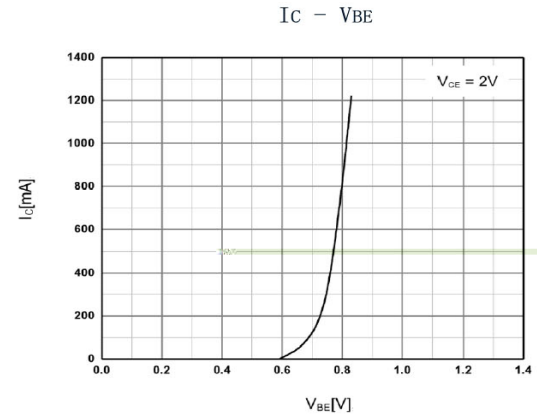
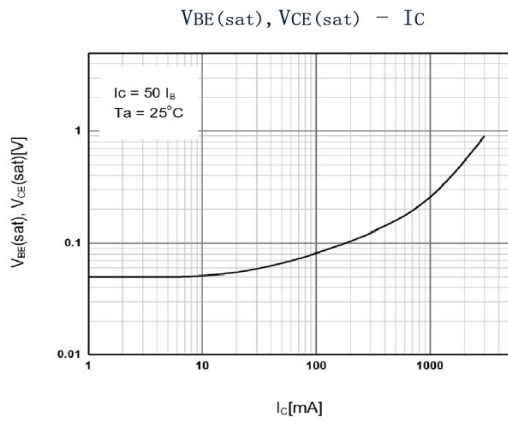
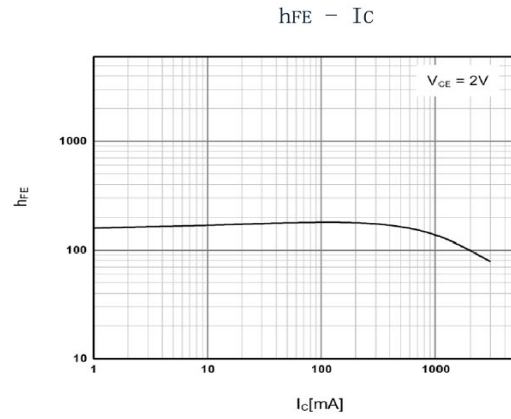
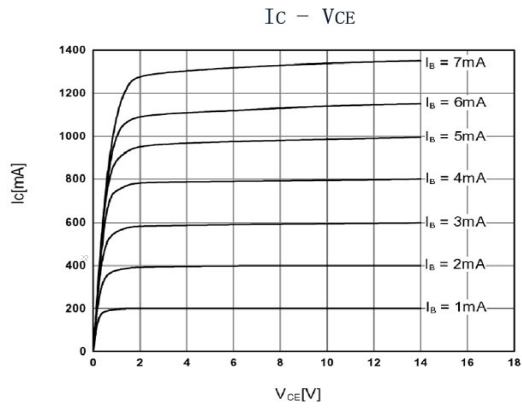

TO-92LM

Unit: mm

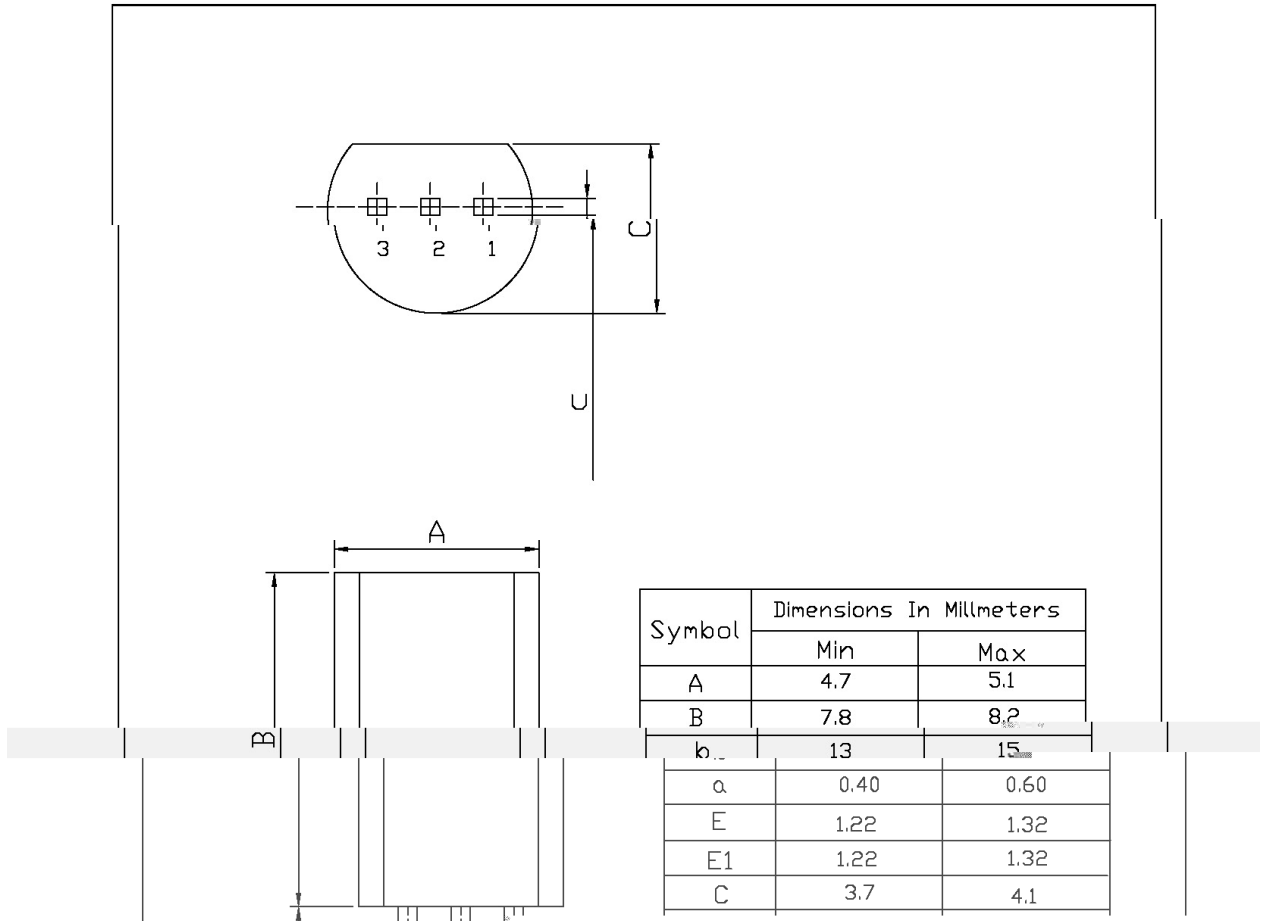

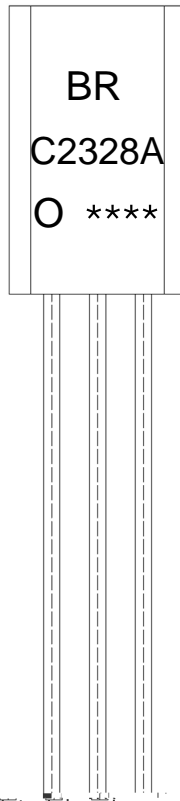

BR:

C2328A

O: h_{FE}

Note:

BR: Company Code.

C2328A: Product Type.

O: h_{FE} Classifications Symbol

****: Lot No. Code,code change with Lot No.

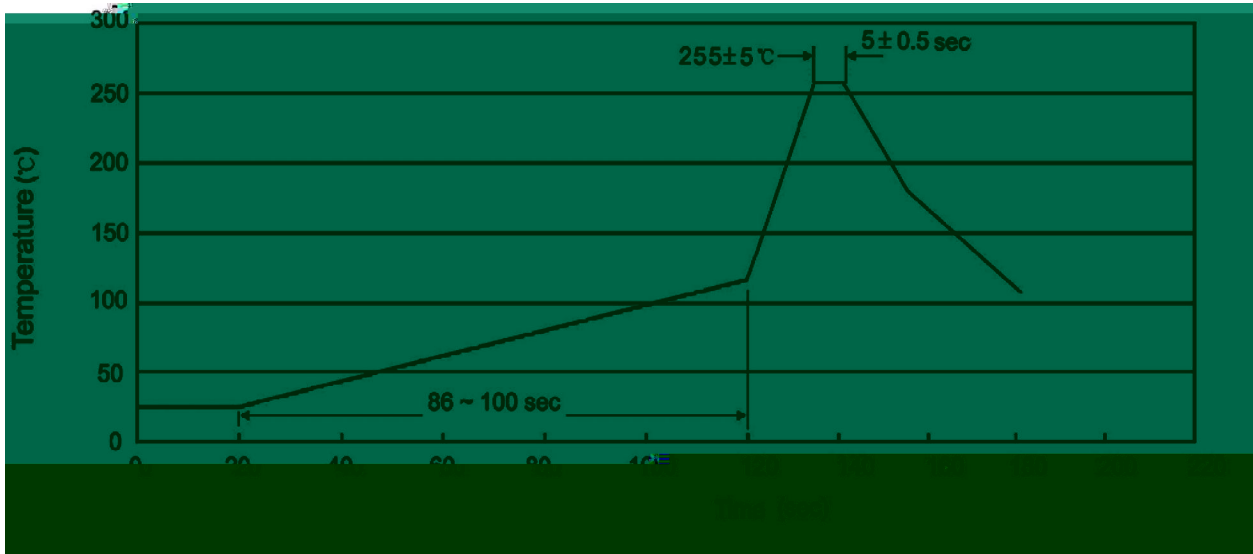
Note:

- | | | | | | |
|---|-------|-----|-----------|--------|---|
| 1 | 25 | 150 | 60 | 90sec; | 1.Preheating:25~150 , Time:60~90sec. |
| 2 | 255±5 | | 5±0.5sec; | | 2.Peak Temp.:255±5 , Duration:5±0.5sec. |
| 3 | | 2 | 10 | /sec. | 3. Cooling Speed: 2~10 /sec. |

270±5

10±1 sec.

Temp.:270±5

Time:10±1 sec

/ BULK

Package Type	Units					Dimension (unit mm3)		
	Units/Bag /	Bags/Inner Box /	Units/Inner Box /	Inner Boxes/Outer Box /	Units/Outer Box /	Bag	Inner Box	Outer Box
TO-92LM	1,000	8	8,000	5	40,000	135×190	237×172×102	560×245×195

/ AMMO

Package Type	Units					Dimension (unit mm3)	
	Units/tape /	Tape/Inner Box /	Rows/Inner Box /	Inner Boxes/Outer Box /	Units/Outer Box /	Inner Box	Outer Box
TO-92LM	2,500	1	100	10	25,000	328×230×42	480×346×235 547×407×268