

Rev.A Dec.-2023

TO-252 N MOS
N-CHANNEL MOSFET in a TO-252 Plastic Package.

Low gate charge, low crss, fast switching, HF Product. Have good Electromagnetic Interference performance, HF Product.

DC/DC

These devices are well suited for high efficiency switching DC/DC converters and switch mode power supplies.

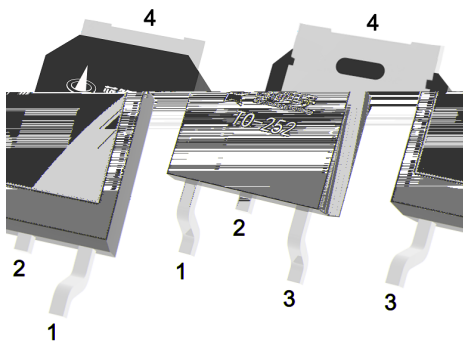
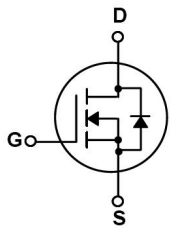

PIN 1 G PIN 2 D PIN 3 S PIN 4 D

See Marking Instructions.

Parameter	Symbol	Rating	Unit
Drain-Source Voltage	V_{DSS}	650	V
Drain Current	$I_D(T_c=25^\circ\text{C})$	7.0	A
Drain Current	$I_D(T_c=100^\circ\text{C})$	4.4	A
Drain Current - Pulsed	I_{DM}	28	A
Gate-Source Voltage	V_{GSS}	± 30	V
Single Pulsed Avalanche Energy	E_{AS}	425	mJ
Avalanche Current	I_{AR}	9.9	A
Power Dissipation	$P_D(T_c=25^\circ\text{C})$	100	W
Operating and Storage Temperature Range	T_j, T_{stg}	-55 to 150	
Junction to Ambient	R_{JA}	110	/W
Junction to Case	R_{JC}	1.25	/W

Parameter	Symbol	Test Conditions	Min	Typ	Max	Unit
Drain-Source Breakdown Voltage	BV_{DSS}	$V_{GS}=0V$ $I_D=250\mu A$	650	690		V
Zero Gate Voltage Drain Current	I_{DSS}	$V_{DS}=650V$ $V_{GS}=0V$			1.0	μA
Gate-Body Leakage Current Forward	I_{GSS}	$V_{GS}=\pm 30V$ $V_{DS}=0V$			± 100	nA
Gate Threshold Voltage	$V_{GS(th)}$	$V_{DS}=V_{GS}$ $I_D=250\mu A$	2.0	3.2	4.0	V
Static Drain-Source On-Resistance	$R_{DS(on)}$	$V_{GS}=10V$ $I_D=3.5A$		1.1	1.5	
Input Capacitance	C_{iss}	$V_{DS}=25V$ $V_{GS}=0V$ $f=1.0MHz$		1000		pF
Output Capacitance	C_{oss}			180		
Reverse Transfer Capacitance	C_{rss}			4		
Total Gate Charge	Q_G	$V_{DS}=520V,$ $I_D=7.0A,$ $V_{GS}=10V$		30		nC
Gate-Source Charge	Q_{GS}			10		
Gate-Drain Charge	Q_{GD}			21		
Turn-On Delay Time	$t_{d(on)}$	$V_{DD}=325V$ $I_D=7.0A$ $R_G=25$ $V_{GS}=10V$		52		ns
Turn-On Rise Time	t_r			160		
Turn-Off Delay Time	$t_{d(off)}$			400		
Turn-Off Fall Time	t_f			190		
Drain-Source Diode Forward Voltage	V_{SD}	$V_{GS}=0V,$ $I_S=7.0A$			1.4	V

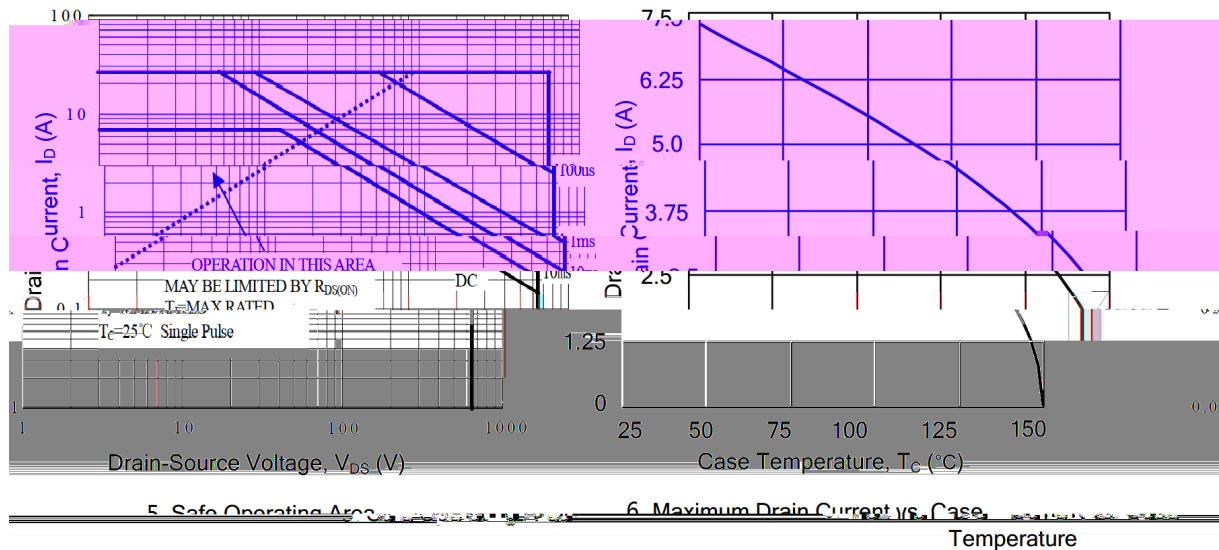
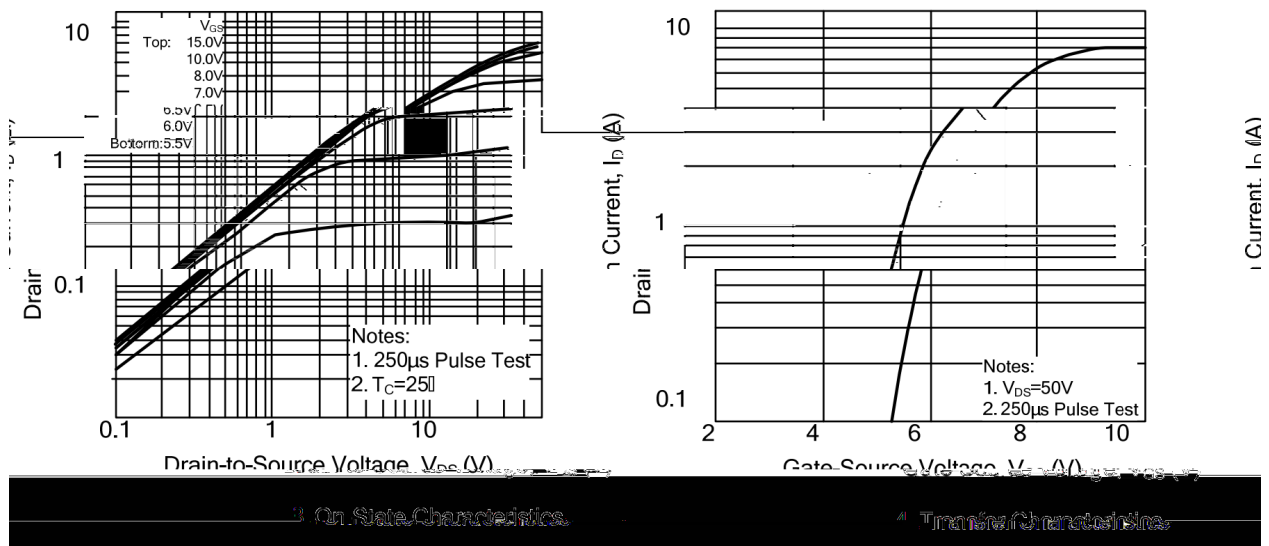
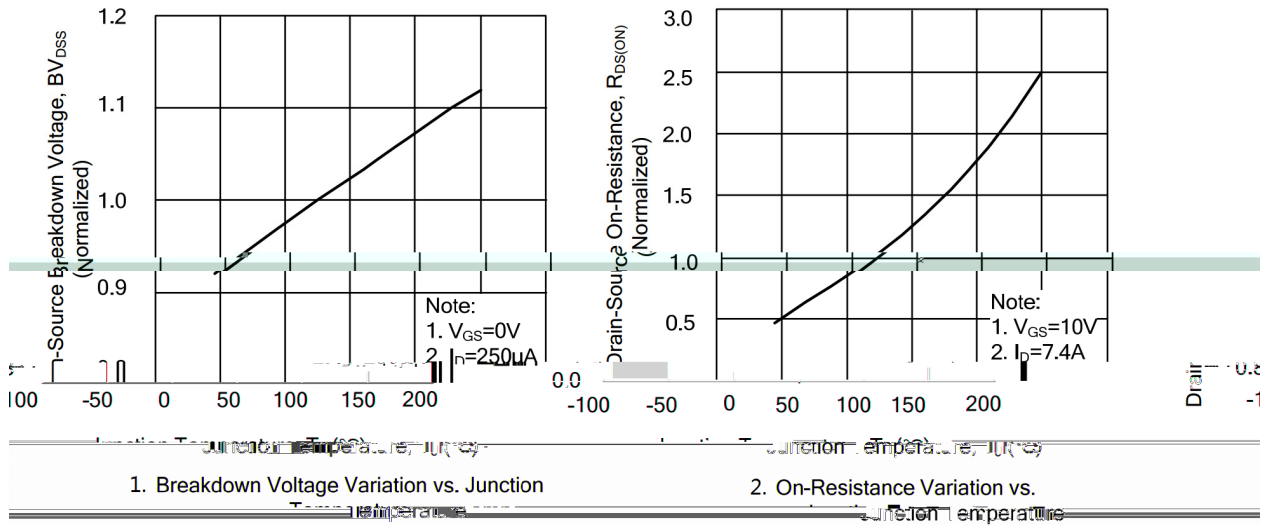

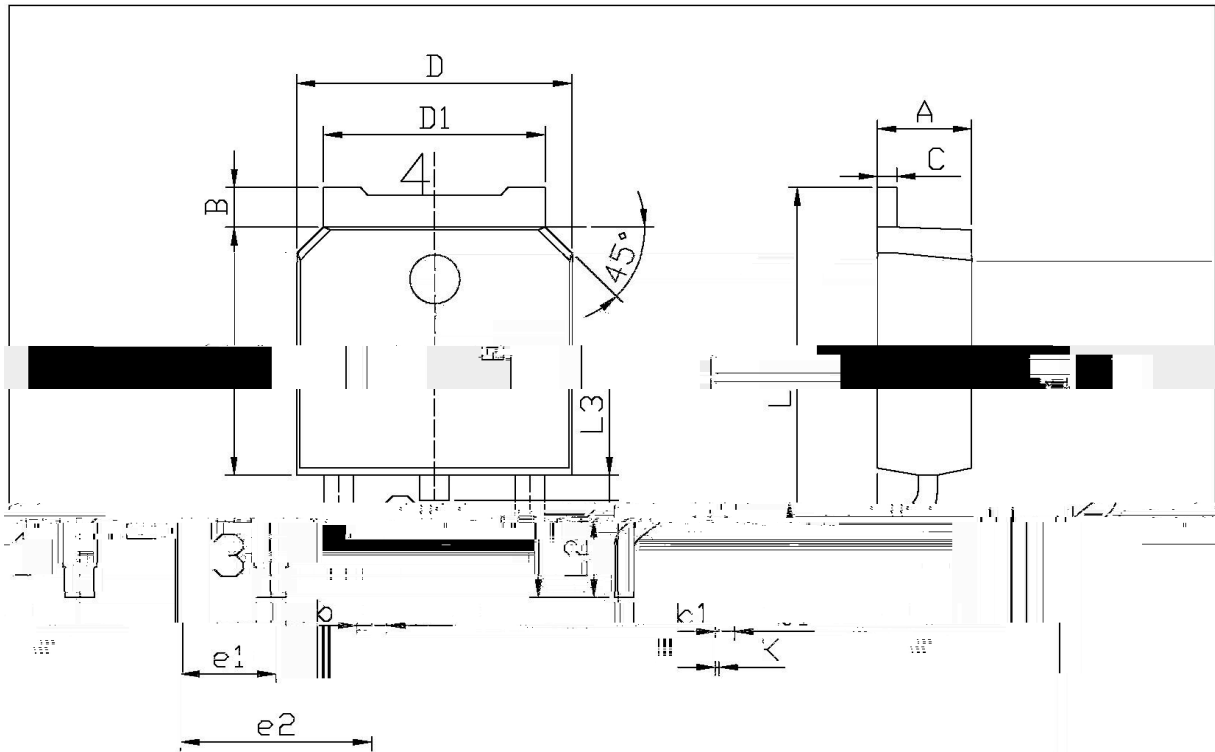

单位: mm

Symbol	Dimensions In Millimeters		Symbol	Dimensions In Millimeters	
	Min	Max		Min	Max
5.95	6.25		A	2.20	2.40
2.24	2.34		B	0.95	1.25
e4.73	4.73		e1	0.70	0.90
L1	9.85	10.35	L1	0.45	0.55
		0.15		0.70	0.90
0.75	L3	0.60	D1	6.45	6
0.50	K5	0.00	J11	5.10	5

□-252

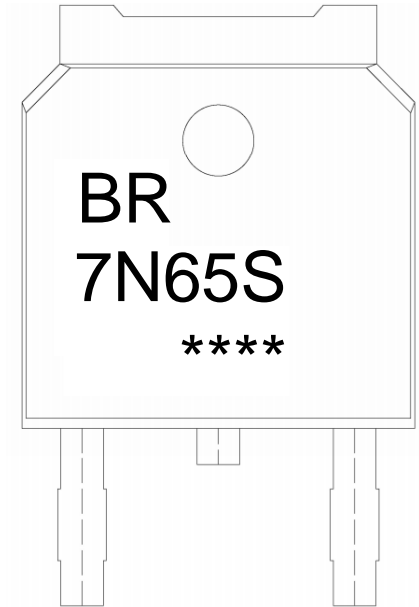

BR

7N65S

Note:

BR:

Company Code

7N65S:

Product Type Code

****:

Lot No. Code, code change with Lot No

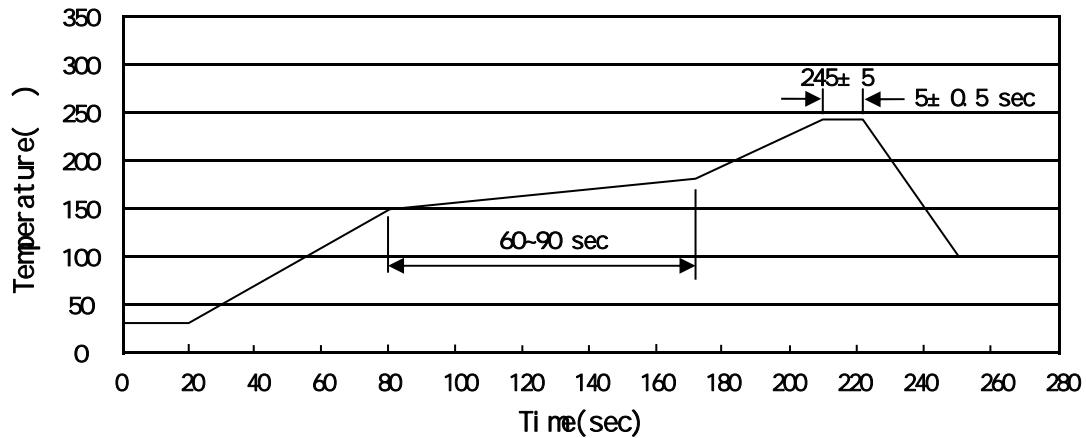
Temperature Profile for IR Reflow Soldering(Pb-Free)

Note:

- | | | | | | |
|---|-------|-----|-----------|--------|-----------------------------------------|
| 1 | 150 | 180 | 60 | 90sec; | 1.Preheating:150~180 , Time:60~90sec. |
| 2 | 245±5 | | 5±0.5sec; | | 2.Peak Temp.:245±5 , Duration:5±0.5sec. |
| 3 | | 2 | 10 | /sec. | 3. Cooling Speed: 2~10 /sec. |

260±5

10±1 sec.

Temp.:260±5

Time:10±1 sec

/ REEL

Package Type	Units					Dimension (unit mm ³)		
	Units/Reel	Reels/Inner Box	Units/Inner Box	Inner Boxes/Outer Box	Units/Outer Box	Reel	Inner Box	Outer Box
TO-252	2,500	2	5,000	6	30,000	13 x16	360x360x50	380x335x366

/ TUBE

Package Type	Units					Dimension (unit mm ³)		
	Units/Tube	Tubes/Inner Box	Units/Inner Box	Inner Boxes/Outer Box	Units/Outer Box	Tube	Inner Box	Outer Box
TO-251/252	75	48	3,600	5	18,000	526x20.5x5.25	555x164x50	575x290x180