

/ Descriptions

PDFN5×6 N

/ Features

/ Applications

LED

/ Equivalent Circuit

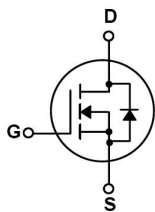

/ Pinning

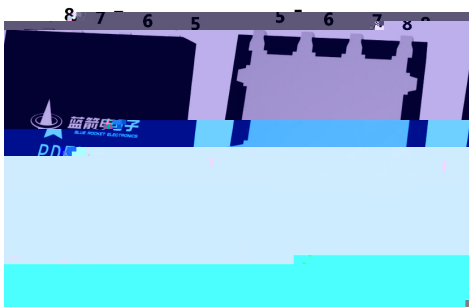

/ Marking

/ Electrical Characteristic Curve

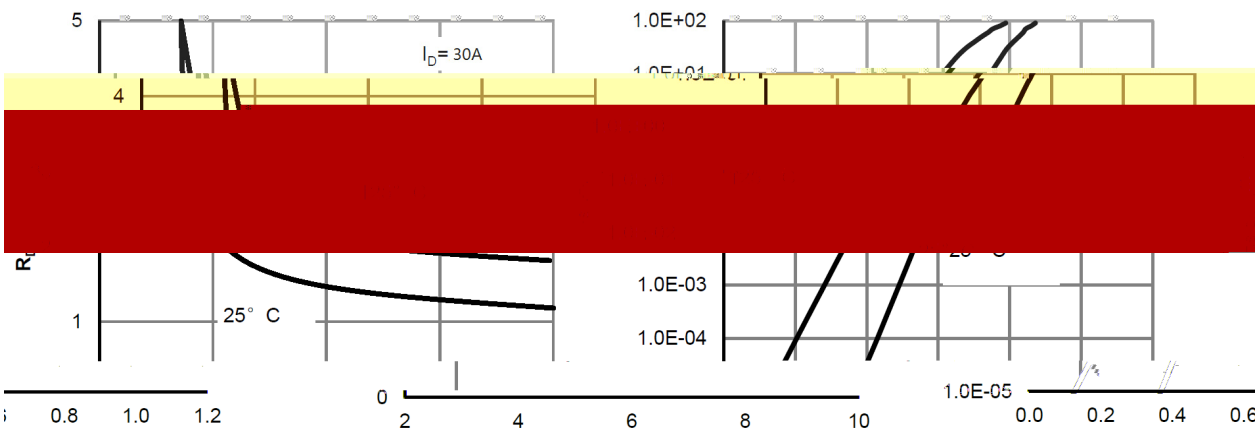
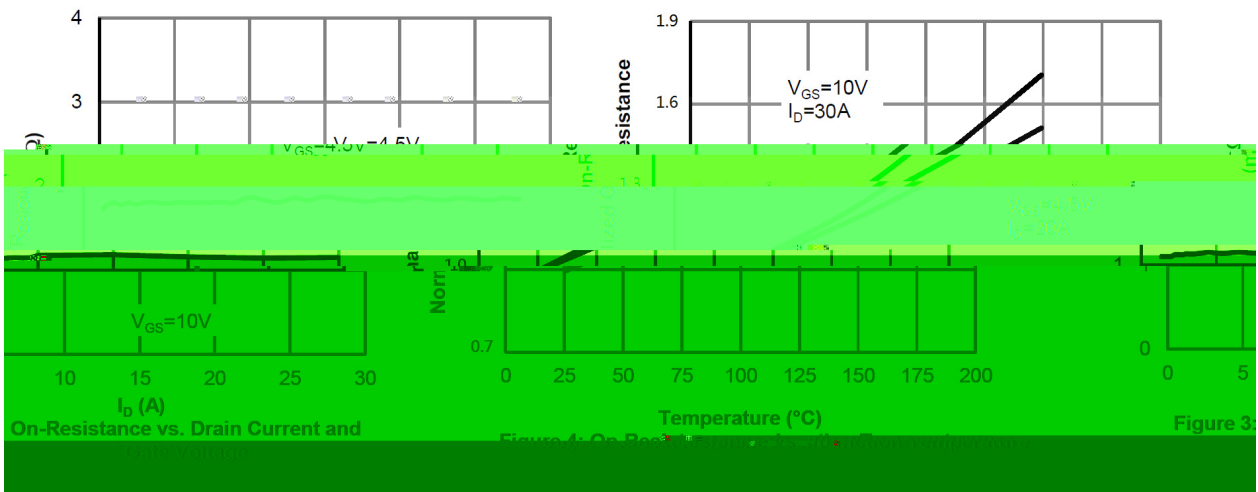
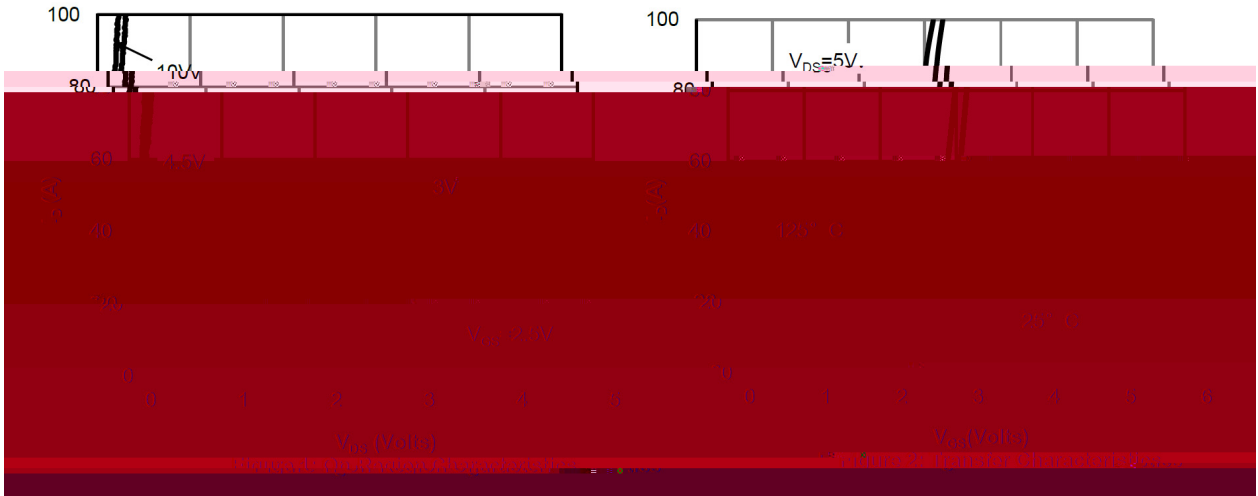
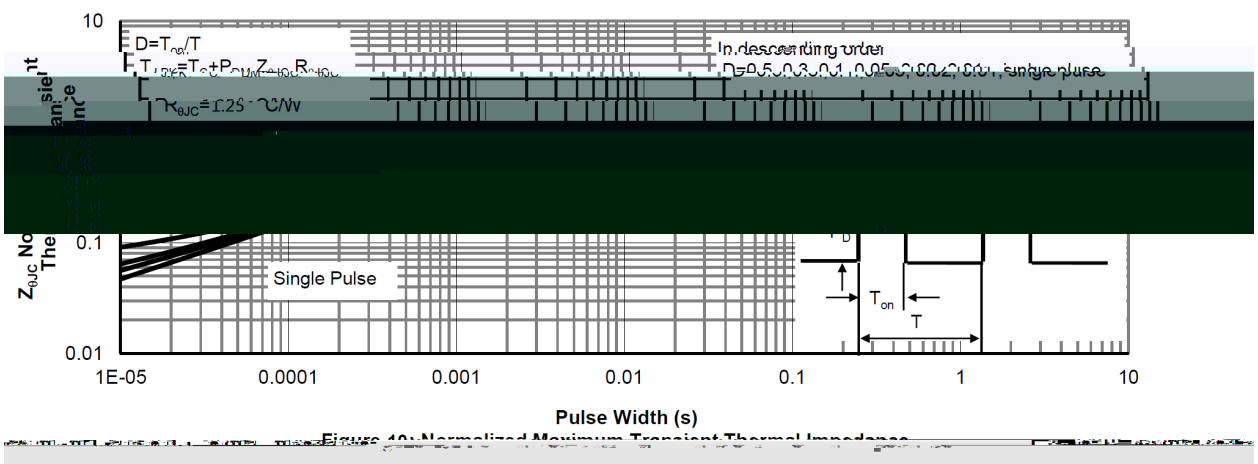
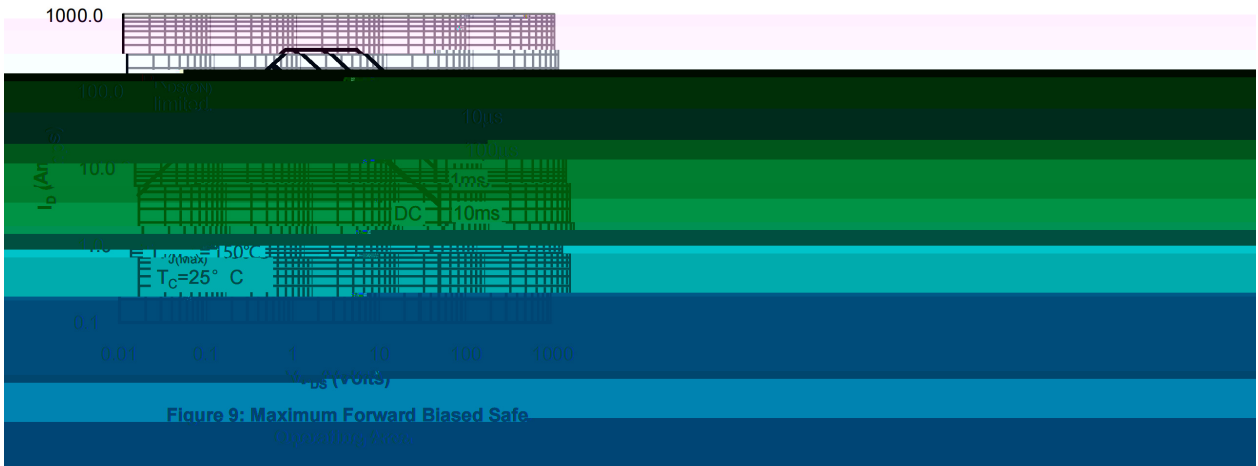
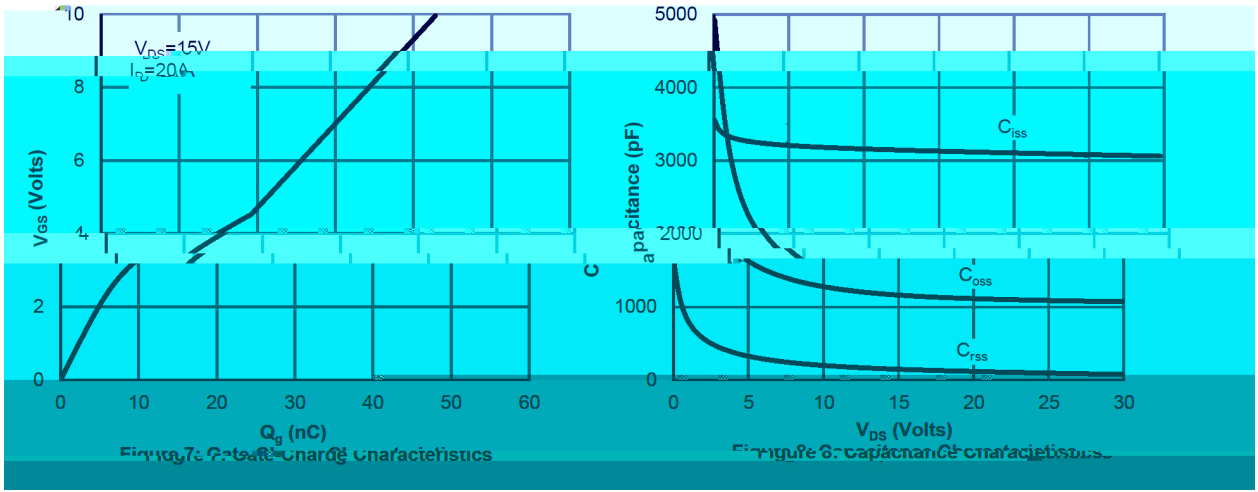

Figure 4: On-Resistance vs. Drain Current and Temperature

Figure 5: On-Resistance vs. Gate-Source Voltage

Figure 6: Body-Diode Characteristics

/ Electrical Characteristic Curve



/ Package Dimensions

PDFN5 X6

Unit:mm

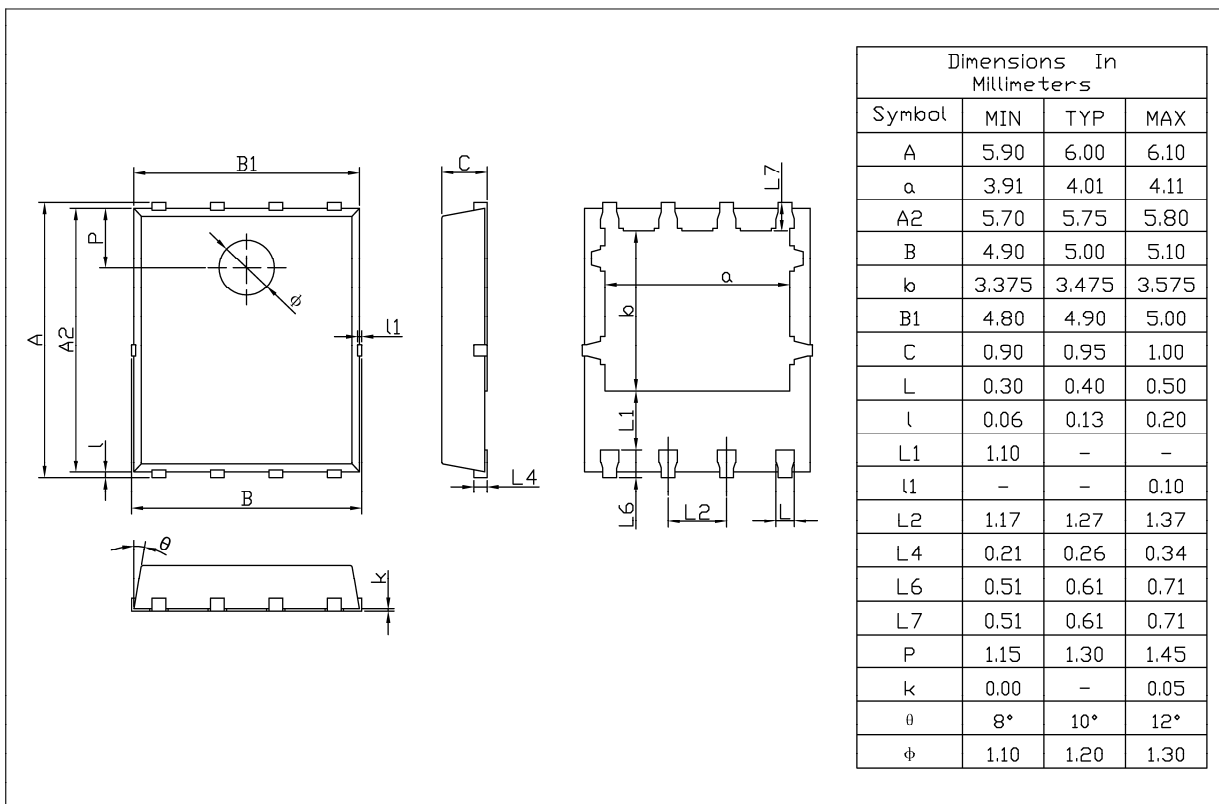

Rev.02 202510

/ Marking Instructions

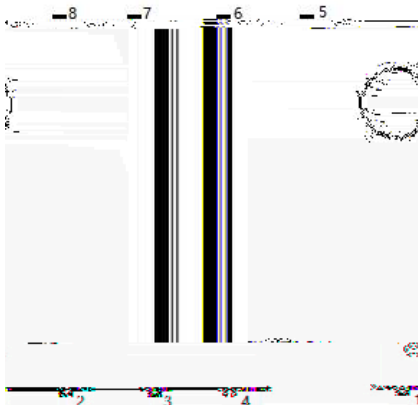

BR

() /

± ± ± ±

/ Resistance to Soldering Heat Test Conditions

± ±

/ Packaging SPEC.