

2SC2705

TO-92LM

NPN

, 2SA1145

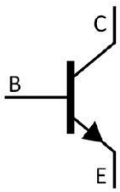



						μ
						μ

/ Electrical Characteristic Curve

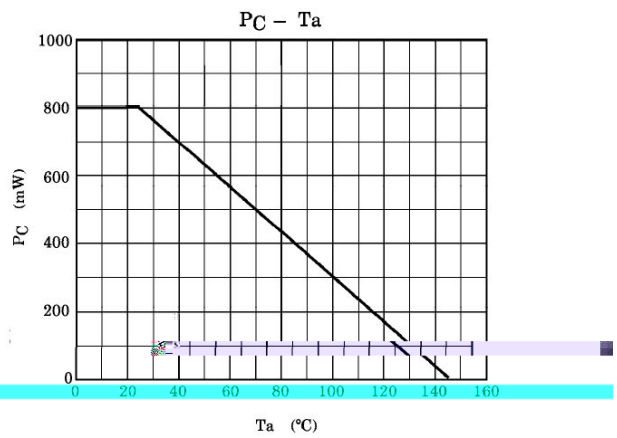
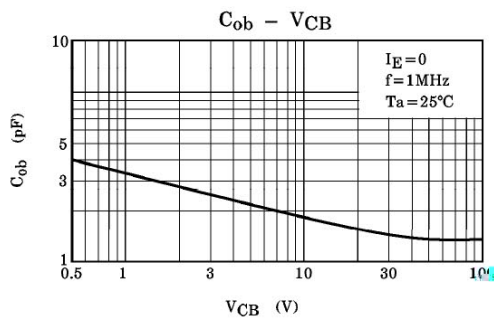
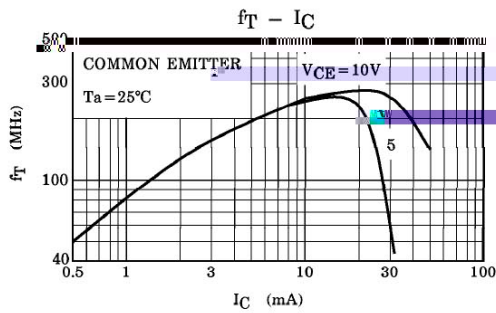
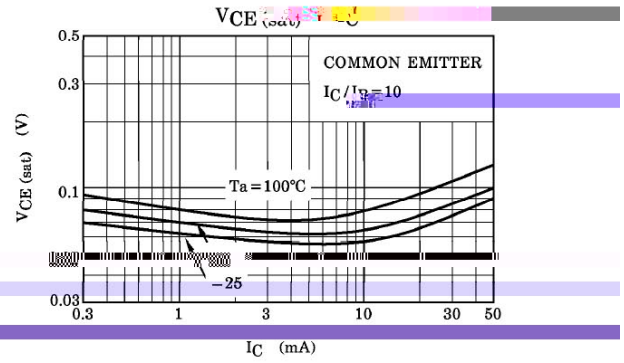
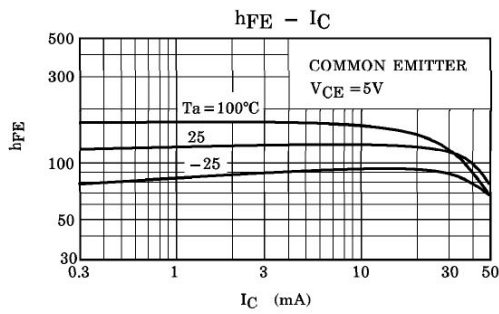
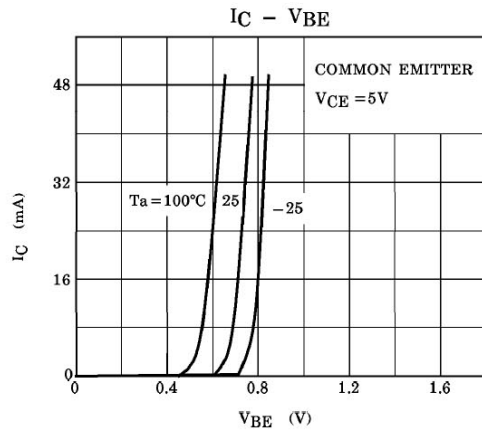
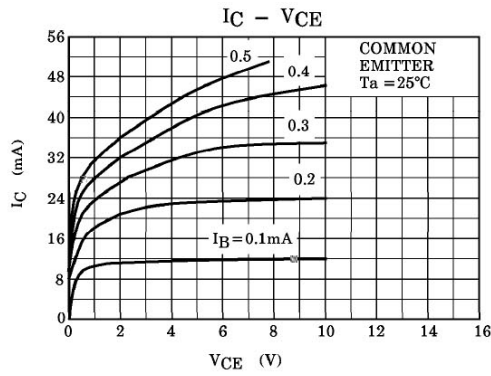

/ Package Dimensions

T0-92LM

Unit: mm

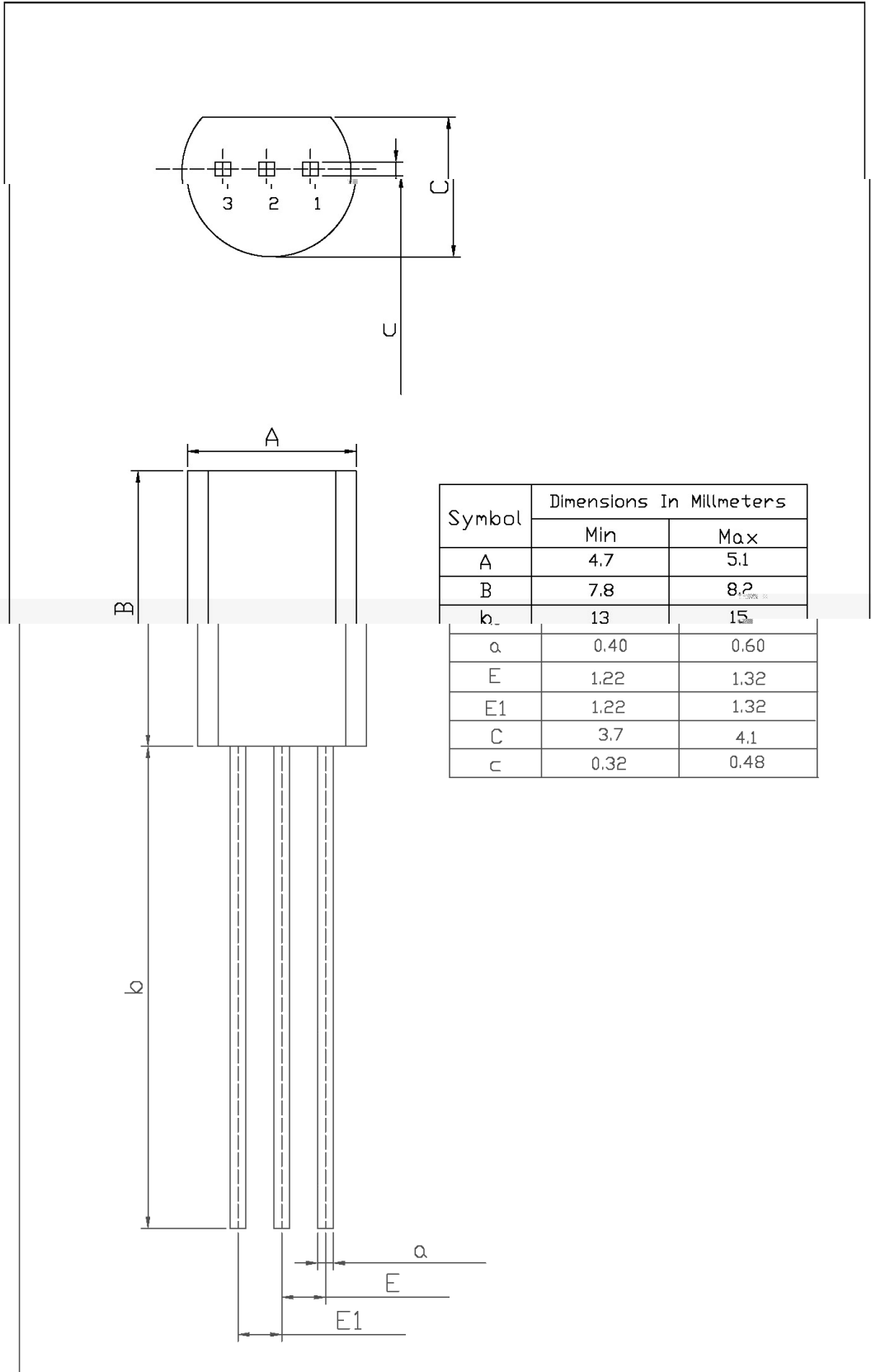

2SC2705

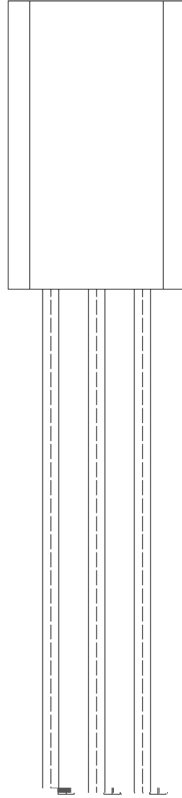

() / Temperature Profile for Dip Soldering(Pb-Free)

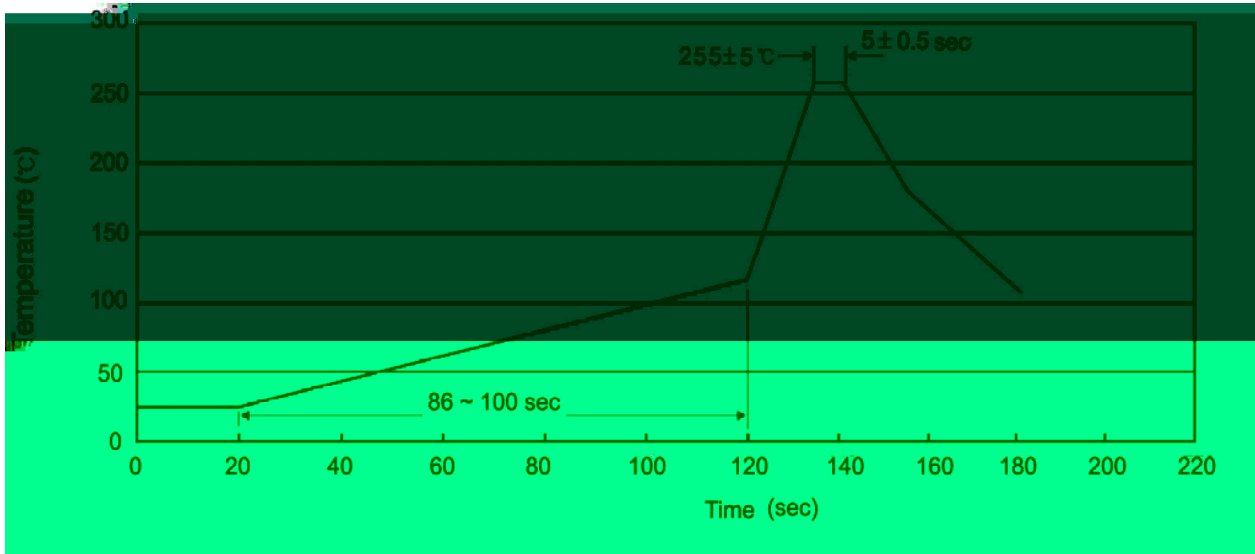

± ± ± ±

/ Resistance to Soldering Heat Test Conditions

± ±

/ Packaging SPEC.

	Units/Bag	Bags/Inner Box	Units/Inner Box	Inner Boxes/Outer Box	Units/Outer Box	Bag	Inner Box	Outer Box
TO-92LM	1,000	8	8,000	5	40,000	135×190	237×172×102	560×245×195

	Units/tape	Tape/Inner Box	Rows/Inner Box	Inner Boxes/Outer Box	Units/Outer Box	Inner Box	Outer Box
TO-92LM	2,500	1	100	10	25,000	328×230×42	480×346×235 547×407×268

/ Notices