

TO-92LM PNP Silicon PNP transistor in a TO-92LM Plastic Package.

2SC2705

High transition frequency, small collector output capacitance complementary pair with 2SC2705.

Audio frequency amplifier applications.

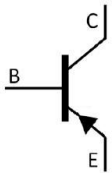

PIN1 Base PIN 2 Collector PIN 3 Emitter

h_{FE} Classifications Symbol	O	Y
h_{FE} Range	80~160	120~240

Parameter	Symbol	Rating	Unit
Collector to Base Voltage	V_{CBO}	-150	V
Collector to Emitter Voltage	V_{CEO}	-150	V
Emitter to Base Voltage	V_{EBO}	-5.0	V
Collector Current - Continuous	I_C	-50	mA
Base Current	I_B	-5.0	mA
Collector Power Dissipation	P_C	800	mW
Junction Temperature	T_j	150	
Storage Temperature Range	T_{stg}	-55~150	

Parameter	Symbol	Test Conditions	Min	Typ	Max	Unit
Collector to Emitter Breakdown Voltage	V_{CEO}	$I_C=-1.0mA$ $I_B=0$	-150			V
Collector Cut-Off Current	I_{CBO}	$V_{CB}=-150V$ $I_E=0$			-0.1	μA
Emitter Cut-Off Current	I_{EBO}	$V_{EB}=-5.0V$ $I_C=0$			-0.1	μA
DC Current Gain	h_{FE}	$V_{CE}=-5.0V$ $I_C=-10mA$	80		240	
Collector to Emitter Saturation Voltage	$V_{CE(sat)}$	$I_C=-10mA$ $I_B=-1.0mA$			-1.0	V
Base to Emitter Voltage	V_{BE}	$V_{CE}=-5.0V$ $I_C=-10mA$			-0.8	V
Transition Frequency	f_T	$I_C=-10mA$ $V_{CE}=-5.0V$		200		MHz
Collector output capacitance	C_{ob}	$V_{CB}=-10V$ $I_E=0$ $f=1.0MHz$		2.5		pF

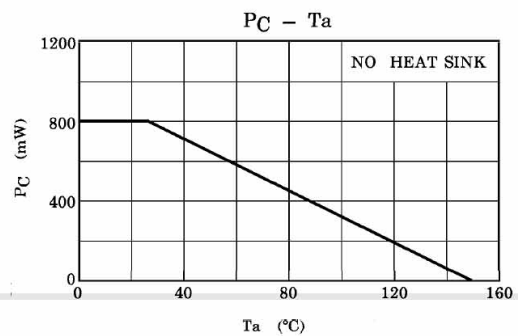
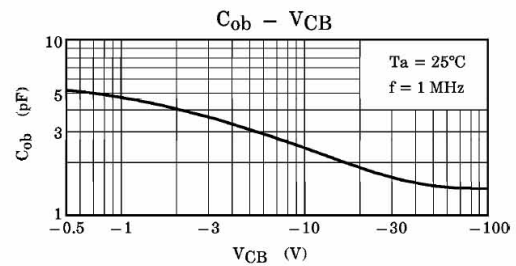
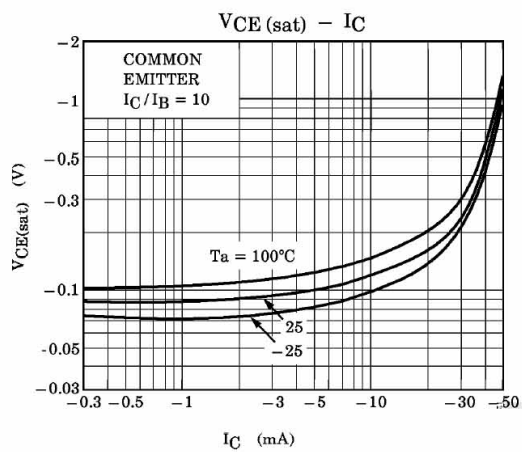
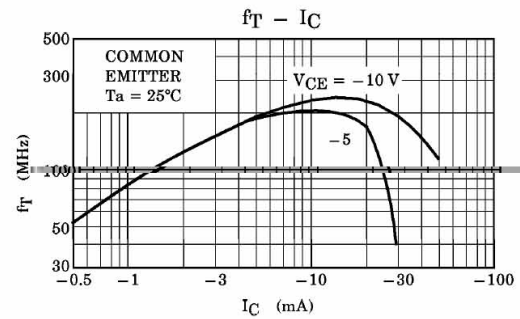
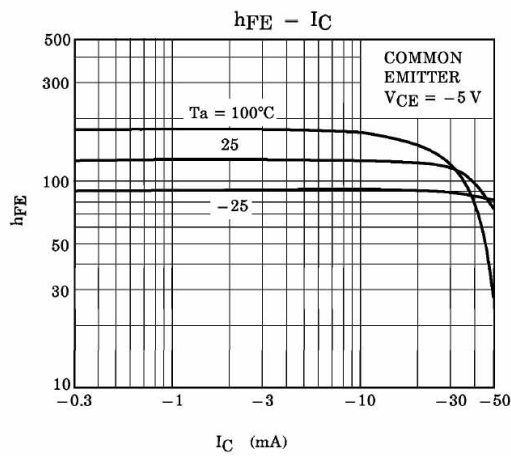
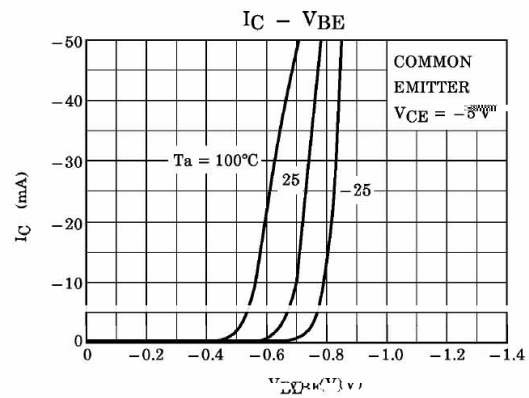
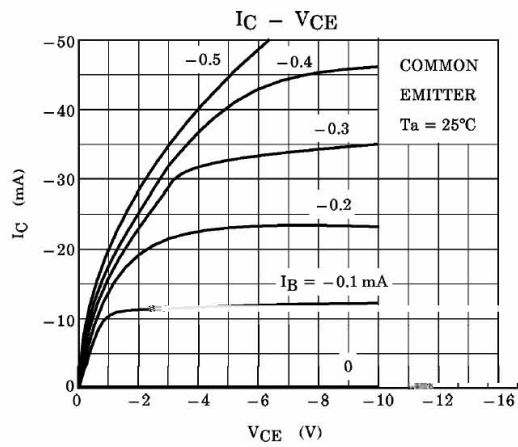

T0-92LM

Unit: mm

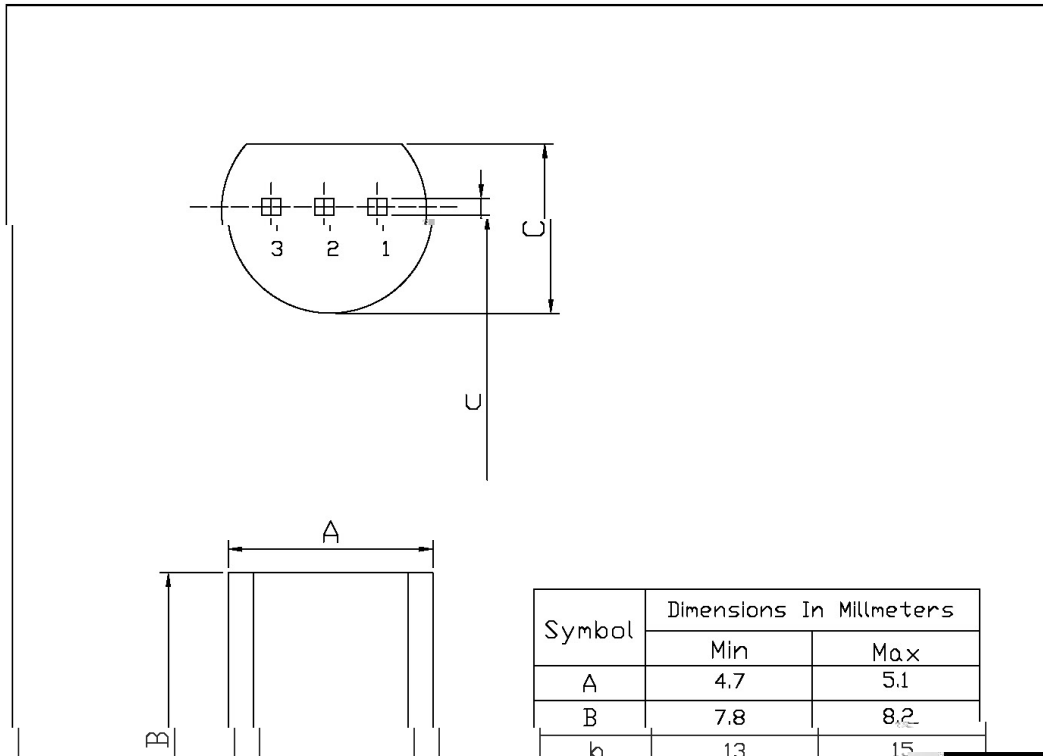

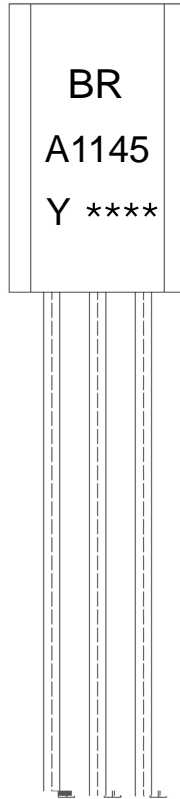

BR:

A1145

Y: h_{FE}

Note:

BR: Company Code.

A1145: Product Type.

Y: h_{FE} Classifications Symbol

****: Lot No. Code, code change with Lot No.

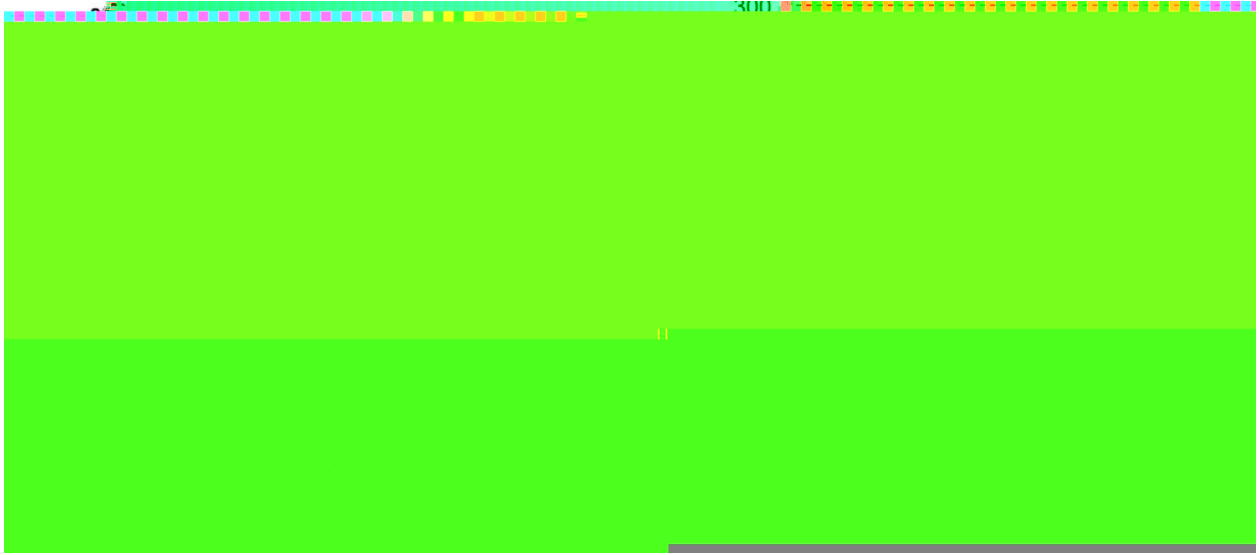
Note:

- | | | | |
|---|--------|-----------|---|
| 1 | 25 150 | 60 90sec; | 1.Preheating:25~150 , Time:60~90sec. |
| 2 | 255±5 | 5±0.5sec; | 2.Peak Temp.:255±5 , Duration:5±0.5sec. |
| 3 | 2 10 | /sec. | 3. Cooling Speed: 2~10 /sec. |

270±5 10±1 sec. Temp.:270±5 Time:10±1 sec

/ BULK

Package Type 封装形式	Units 包装数量					Dimension 包装尺寸 (unit: mm3)		
	Units/Bag 只/袋	Bags/Inner Box 袋/盒	Units/Inner Box 只/盒	Inner Boxes/Outer Box 盒/箱	Units/Outer Box 只/箱	Bag 袋	Inner Box 盒	Outer Box 箱
TO-92LM	1,000	8	8,000	5	40,000	135×190	237×172×102	560×245×195

/ AMMO

Package Type 封装形式	Units 包装数量					Dimension 包装尺寸 (unit: mm3)	
	Units/tape 只/纸带	Tape/Inner Box 纸带/盒	Rows/Inner Box 纸带层/盒	Inner Boxes/Outer Box 盒/箱	Units/Outer Box 只/箱	Inner Box 盒	Outer Box 箱
TO-92LM	2,500	1	100	10	25,000	328×230×42	小箱 480×346×235 大箱 547×407×268